



Radiation Protection &
Nuclear Security



Radon, Thoron,
Daughter Products &
Radioactive Aerosols



Environmental,
Pollution & Security
Monitoring



Gas Monitoring &
Geochemistry



Contents

Application / Instrument – Aerosol Monitors	3
Application / Instrument – Radon / Thoron.....	4
A²M 4000 – Radioactivity and gas monitoring system	5
Lab Scout – Gamma identifier/quantifier with integrated scale	8
MyRIAM – Personal dosimeter for inhalation dose.....	10
NucScout – Doserate meter and nuclide identifier.....	12
poCAMon – Personal online continuous air monitor	15
Aer 5200 – HV Online Air Sampler.....	18
Spectra 5011/5031 – Universal Alpha/Gamma spectrometer	21
VacuTube – Extension for the SARAD SPECTRA 50xx MCA-series	23
Detectors – Ion-implanted silicon detectors for alpha spectroscopy	25
MOD-01/03 & 01/04 – Detector modules for alpha spectroscopy	26
Radon Scout Home – Personal home monitor	27
DOSEman – Radon Exposimeter/Dosimeter	29
DOSEman PRO – Radon daughter product Dosimeter.....	31
EQF 3200 – Radon/Thoron gas and daughter product monitor system.....	33
EQF 3220 – Particle size specific Rn/Tn gas & daughters monitor	36
Radon Scout / Plus – Indoor Radon monitor.....	39
Thoron Scout – Radon & Thoron measurements.....	42
Radon Scout PMT – Radon monitor with Lucas cell.....	44
Indoor Air Sensor – Stationary Radon monitor & transmitter	46
RTM 1688-2 – Radon and Thoron monitor	48
RTM 1688-2 Geo Station – Radon and Thoron monitor.....	50
RTM 2200 – Radon and Thoron measurement system.....	52
Radon Soil Gas Probe – Sensors for many different target gases.....	55
Gas Sensors – Sensors for many different target gases	56
Pollution Monitoring Station – Autonomous immission monitor	59
Pollution Monitoring – Autonomous immission/emmission monitoring ...	60
ASDA 02 Cascade Impactor – Particle size distribution monitor	61
ABC Reconnaissance CAR – Detection of dangerous materials	62

Application / Instrument – Aerosol Monitors

	● particularly suitable	○ condition. suitable	- not suitable				
Time-resolved results of measurement	●	●	●	●	●	●	●
Short-term measurements/ Overview measurements	●	●	●	●	●	●	●
Long-term measurements/ Area Monitoring	○	●	●	●	●	●	○
Radon gas in the air			○		●	●	-
Radon daughters (EEC Radon)	●	●	●	●	●	●	-
Long-living radioactive Dust (LLRD)	-	●	●	●	-	-	●
Patient Monitoring (Radiotherapie)	-	●	●	●	●	●	-
Personnel Monitoring	●	●	○	○	-	-	●
Emergency situations	-	●	●	●	●	●	●
Multiparameter systems (Gas Sensors, Gamma-Detectors, etc.)	-	●	●	●	●	●	-
Mining	●	●	-	○	●	●	●
Measurement of Radon in water probes (drinking water etc. (with Radon bubbler)	-	-	-	-	●	●	-
Continuous Radon in soil gas measurement	-	-	-	-	●	●	-
Continuous Radon-in- water measurement	-	-	-	-	●	●	-
Outside Radon measurements (low-level)	○	●	●	●	●	●	○
Wireless networks (Modem, GSM)	-	●	●	●	●	●	●
Ventilation control	-	-	●	●	●	●	-

Application / Instrument – Radon / Thoron

● <i>particularly suitable</i> ○ <i>condition. suitable</i> - <i>not suitable</i>								
Time-resolved results of measurement	●	●	●	●	●	●	●	●
Short-term measurements / Overview measurements	○	○	●	○	○	●	●	●
Long-term measurements/ Buildings evaluation	○	●	●	●	●	●	○	○
Search for Radon/Thoron entries (Sniffing mode)	-	-	-	-	-	-	●	○
Thoron measurement	-	-	●	-	-	-	●	●
Exhalation measurement	○	○	○	-	-	○	●	●
Personal dosimetry	●	-	-	○	○	●	-	-
Area dosimetry	○	●	●	●	●	●	○	○
Short-term measurement of Radon/Thoron concentration in soil gas	○	-	-	-	-	-	●	●
Measurement of Radon in water probes (drinking water etc. (with Radon bubbler)	-	-	-	-	-	-	●	●
Continuous soil gas measurement	○	-	-	-	-	-	●	●
Continuous water measurement	-	-	-	-	-	-	●	●
Outside Radon measurements (low level)	-	○	○	-	-	○	●	●
Multi parameter systems (additional gas sensors, etc.)	-	-	-	-	-	-	-	●
Ventilation control	-	●	●	●	-	-	-	-
SCADA-integration	-	●	●	●	●	●	-	-
Wireless networks (Modem, GSM, Ethernet, etc.)	-	●	●	●	●	●	●	●

A²M 4000

Radioactivity and gas monitoring system



The A²M 4000 is the very first portable and battery powered instrument that combines various types of detectors and components for almost any measurement task in the field of radiation protection. This instrument is specially suitable for:

Definition of a local dose, detection of radioactive sources: The handy and robust NaI(Tl) detector is connected to the unit via a 10m long cable, so that it can be positioned flexibly in relation to the source. Thanks to the big detector volume, even small sources can be detected.

Net activity of free definable nuclides in food and material probes: The NaI(Tl) detector is also used to analyze food and material probes regarding specific nuclides (e.g. Iodine, Caesium, Americium). By means of the gamma spectrum, the net activity of seven user definable nuclides is automatically calculated. A lead shield against the environmental radiation is an optional accessory.

Measurement of radioactive aerosols in inhaled air (Alpha/Beta CAM): The aerosol sampling head with its spectroscopy filter and its silicon detector samples continuously and detects even small quantities of aerosol carried radioactivity. Both alpha and beta radiation are measured. The spectrometric analysis allows e.g. detecting Plutonium aerosols which cannot be detected by measuring gamma radiation.

Mop tests, surface contamination (clothes), electrochemical probes: Optionally, the A²M 4000 can be connected to a portable vacuum chamber, to allow on-site analysis of mop tests and other samples under circumstances similar to those prevailing in a laboratory. The employed vacuum pumps can be connected to a 12V source (car battery).

Toxic and explosive gases: Optionally, sensors to detect toxic and combustible gases (e.g. CO, CO₂, CH₄) can be integrated.

All detectors can be operated simultaneously. The concept of the system allows an easy handling and a standardized data basis. The device offers predefined measurement procedures that can be easily modified by the user. Additional measurement programs can be created without any problem.

The A²M 4000 disposes of a big touch-screen, showing the measured values. All measured data are stored in a 2GB memory card and are available from your PC or laptop through a USB interface. Data transmission and device control can be done by GPRS or GSM modems, as well as via Net Monitors ZigBee wireless adapter, if the device is operated in inaccessible or contaminated areas.

A²M 4000

Radioactivity and gas monitoring system

Aerosol sampler (CAM)	Fix mounted at the A ² M4000 front panel
Detector	400mm ² ion-implanted silicon detector
Filter	Membrane filter, d=27mm, 1µm pore size <ul style="list-style-type: none"> ▶ Active filter monitoring against perforation, exhaustion, ▶ No tool for filter replacement required
Pump	Rotary vane type 3 l/min, processor controlled
Analysis/results	Exposure and dose for both, alpha and beta aerosols (LLRD) <ul style="list-style-type: none"> ▶ Compensation of natural Radon daughters background ▶ Radon/Thoron EEC/PAEC are calculated separately ▶ Storage of time distribution (results as well as spectra)
Detection limits LLRD	at typical Radon outdoor concentration of 5 Bq/m ³ <ul style="list-style-type: none"> ▶ 1 min sampling interval < 100 Bq/m³ ▶ 10 min sampling interval < 0.1 Bq/m³
Gamma probe	<i>Connection via cable at the A²M4000 front panel</i>
Detector	Sodium-Iodide (NaI(Tl)) with integrated PMT und Bias <ul style="list-style-type: none"> ▶ Scintillation crystal 2" x 2" ▶ Energy range for spectroscopy 10keV – 3MeV or 10keV - 1,5MeV ▶ Spectral resolution 8% (Cs-137)
Results / Analysis	Count rate, dose rate (energy compensated), Net-activity of seven user defined nuclides <ul style="list-style-type: none"> ▶ Storage of record related spectra and time distribution
Probe dimensions	Diameter 60mm, length 260mm <ul style="list-style-type: none"> ▶ Cable 5m (optional 10m)
Sensitivity	1000 cps/(µSv/h) related to Cs-137
Vacuum chamber (Option)	<i>Connection via cable at the A²M4000 front panel</i>
Detector	Ion-implanted Silicon detector 400mm ² (optionally up to 2000mm ²) Alpha 0-10MeV, Beta from approx. 180keV (400mm ²)
Connection	Cable for detector and vacuum control, 1m each Pump connector 4mm Quick-Lock tube connector
Sample holder	Plate for 1 and 2 inch samples, max. distance between sample and detector 40mm <ul style="list-style-type: none"> ▶ Reverse bias voltage included
Chamber	Aluminium anodized, easy to disassemble for cleaning purposes Vacuum control by pressure sensor und 3-path valve
Dimension	243mm x 195mm x 150mm
Results / Analysis	Alpha spectrum

A²M 4000

Radioactivity and gas monitoring system

Additional sensors	
Standard	Flow rate 0 ... 4 l/min, uncertainty ± 5%
Air analytics (option)	CO, CO ₂ , CH ₄ , combustible gases, several ranges
Water analytics (option)	pH value, Redox potential, conductivity etc.
Process (option)	Pressure, differential pressure, flow, velocity etc.
Meteorological (option)	Wind direction, wind speed etc.
Common	
Sampling	Simultaneous measurement with all detectors/sensors with respect to the selected sampling cycle
Sampling cycles	Storage of up to 16 different sampling cycles with up to 32 steps (pre-defined or infinite repetition) <ul style="list-style-type: none">▶ Interval 1 Second to several weeks
Data memory	SD Card, 2 GByte
Controlling	Touch-Screen 6 x 9cm
Interface	USB, RS232, Net Monitors ZigBee wireless optionally
Power supply	Internal 12V rechargeable battery, mains power adapter Optionally additional connector for 12V car battery or solar power supply
Dimensions/weight	235mm x 140mm x 255mm / 6kg
Software	<ul style="list-style-type: none">▶ dVISION: Control and data transfer (also via TCP/IP, GPRS, GSM, ZigBee), visualization, data management▶ dCONFIG: system configuration, creating/changing cycles (also via TCP/IP, GPRS, GSM, ZigBee)▶ dLIBRARY: Library/Calibration for NaI gamma probe compatible with TOMAS (Tracking Online Monitoring und Alarm System)
Extensions	Available at internal connectors: <ul style="list-style-type: none">▶ 8 analogous inputs,▶ 3 counter inputs,▶ 2 status inputs,▶ 6 switch outputs,▶ clock switch,▶ PID regulator/analogous output
GPS	GPS coordinates are recorded and stored together with the measurement results. <ul style="list-style-type: none">▶ GIS compatible *.kml files can be exported (can be opened by Google-Earth).▶ Antenna connected by cable.

Lab Scout

Gamma identifier/quantifier with integrated scale



Consumers around the world are afraid of possibly radioactive contaminated foods. Producers, traders and customers want to be sure that limits given by law will not be exceeded.

The Lab Scout is a very easy to operate instrument to detect and quantify natural and artificial radionuclides in material samples. For standard operation procedure neither a computer nor special skills of the operator are required. On the other hand, the instrument can still be used as a flexible and powerful tool in the laboratory.

The high sensitive, temperature compensated 2 by 2 inch NaI detector with magnetic shielding offers an outstanding spectroscopic performance as well as a wide measurement range from 15keV to 3MeV. As an option, a two centimetre thick 360° lead shield is available. This will reduce the background radiation dramatically resulting in a lower statistical error and detection limit.

The included operation software for Windows computers allows an intuitive calibration just by a few mouse clicks using spectra of reference samples. In addition to the energy and peak width calibration an assistant for the efficiency calibration of any sample geometry is included. A number of calibration curves for standard sampling procedures (like Marinelli beaker) will be available to write them into the instrument.

You can create various nuclide lists of up to sixteen lines from an editable library with respect to your measuring problem. The acquired spectrum will be analysed for these lines by the advanced PSV (Peak Shape Verification) method. If a line becomes identified and verified, the weight-specific activity of the emitting nuclide will be calculated due to the integrated scale.

Lab Scout Gamma identifier/quantifier with integrated scale

Detector	Sodium Iodide with integrated PMT and high voltage power supply; scintillation crystal 2" x 2"; energy area: 25 keV – 3MeV; resolution < 7.5% (7% typ.) @ 662keV
Efficiency	net count rate: approx. 1100 cps / (µSv/h) based on Cs-137
Max. Count Rate	20.000 cps
Spectrum	1024 channels
Measurement/ Analysis	<ul style="list-style-type: none">▶ identification of up to 16 peaks (peak list)▶ creating various peak lists from an editable library▶ determination of weight specific nuclide activity
Stabilization	electronic stabilization of temperature; Peak-Pickup by PSV algorithm
Scale	0 ... 2.5 kg
Measuring times	1min; 5min; 15min; ½h; 1h; 4h; 12h; 24h; 48h; 96h
Data Storage	2 GB-SD-Card - more than 780.000 records
Usage/Display	1 Button; signal lights in red, yellow and green; display: 4x20
Acoustic Signal	80dB
Interface/ Software	USB; Lab Scout Works (Analysis, Calibration, Configuration)
Environment	5 ... 35°C; 0 ... 95%
Power Supply	AC/DC adaptor; 12V/250mA, internal 12V rechargeable battery
Dimensions/ Weight	20cm /22cm/52cm (B/T/H); approx. 5.5 kg without lead shielding; with lead shielding approx. 68 kg

MyRIAM

Personal dosimeter for inhalation dose



The personal dosimeter MyRIAM determines the inhalation dose obtained from the exposure to long living Alpha and Beta nuclides (LLRD) in the breathing air.

The aerosols will be accumulated on the surface of a membrane filter by an internal pump. The collected activity is analysed by a semiconductor detector with subsequent Alpha spectroscopy and Beta gross counting.

The influence of natural occurring Radon daughters is fully compensated. An accurate determination of the obtained dose without any additional equipment is possible by a special filter analysis mode. The small filter paper (17,5 mm diameter) can be archived and used for preservation of evidence.

The lightweight (300g) instrument can be worn on the body without impairment of the mobility. Sampling head, battery and electronics have been integrated into a rugged metal enclosure of the size of a mobile phone. Therefore, no additional cables and hoses are required.

Dangerous doses will be detected within 60 Seconds and signalled by an acoustical and an optical alert. The display, equipped with a bright back-light shows the recent dose values (μSv or mrem) as well as the over all count rates. The internal rechargeable battery allows approx. 24 hours of autonomous operation and it takes only one hour to recharge the battery.

No other maintenance is required than the battery recharging and a monthly and easy to perform filter replacement.

The internal data logger enables a chronological (local) assignment of the obtained dose contributions. The communication between PC and MyRIAM is realised by a infrared data link. The software for easy data analysis and archiving is included in delivery.

Power Supply	Internal batteries for approx. 24 hours operation, recharge time approx. 1 hour
Operation	1 Button (with lock function) Display (3 x 12 characters) with back-light
Alarm function	optical (red bright LED at the top of the detector head) acoustical (sounder 85 dB at 2,3 kHz)
Dimensions/ Weight	138 mm x 57 mm x 32 mm / 300g
Interface	Infrared adapter (connection via USB)
Memory	240 Data records and Alpha spectrum
Integration Interval	1 ... 255 minutes (one Minute steps)
Detector	150 mm ² ion-implanted silicon detector
Pump	0.25 L/min membrane type
Filter	0.8 µm PTFE, operable > 1 Month at „normal“ dust exposure
Alpha Spectroscopy	2.8 ... 10 MeV
Energy Window for LLRD Alpha radiation	2,8 ... 5,5 MeV
Lower Beta Cut Off	200 keV
Maximum count rate	100 000 counts per Minute
Software	<ul style="list-style-type: none">▶ Instrument set-up,▶ data download,▶ graphic display of acquired data (exposure, dose, concentration),▶ ASCII Export (EXCEL compatible text file)

NucScout

Doserate meter and nuclide identifier



The NucScout monitors the local dose rate as well as the activity of up to 28 user selectable nuclides. The results are available as time distribution over the whole sampling period. The sampling interval can be adjusted by the user. A complete energy spectrum is saved for each interval on the internal memory card.

The unit is equipped with an integrated GPS receiver which allows the local assignment of the acquired data. The NucScout can be calibrated by the user, so by the way it is possible to determine the detector efficiency for any sampling geometry which can be used later on. The instrument comes with a ZigBee wireless network interface to transfer recent data over several hundred meters to a “base station” computer.

Typical applications are searching for hidden radioactive sources, screening of large contaminated areas based on GIS solutions, process monitoring, tests of building materials or food, and nuclear medicine.

The robust and handsome 2” x 2” NaI detector is fixed to the ergonomic handle while the electronic box can be removed from the handle by a bayonet catch. This allows the user to place the detector in any position to the radioactive source. A sampling table for operation with Marinelli beakers is available. The large detector volume results in a low detection limit so that even weak sources can be found. The wide touch screen makes the operation of the unit comfortable.

The NucScout offers two different algorithms for the activity calculation of the several nuclides. The user may decide between the powerful PSV (peak shape verification) algorithm and the well-known trapezoid method (e.g. for calibration purposes).

Included in the delivery is a comprehensive software package for data download, result presentation, data export, and instrument configuration. A number of tools offer a fast, easy and intuitive detector calibration based on reference sources (energy, peak-width, efficiency) as well as the complete library management. Remote control of the unit is possible via the integrated USB or wireless network.

Gamma probe	
Detector	<p>NaI(Tl) with integrated photo multiplier and high voltage supply</p> <ul style="list-style-type: none"> ▶ Cylindrical scintillation crystal 2" x 2" ▶ Energy range 25 keV – 3 MeV (optional from 10 keV or to 1.6 MeV) ▶ Resolution < 7.5% (typ. 7%) @662keV
Efficiency	Net count rate > 1100 cps / (μSv/h) for Cs-137
Max. count rate	100.000 cps
Range NaI detector	0 - 25μSv/h (Cs-137)
Spectrum	512 channels
Results	<ul style="list-style-type: none"> ▶ Single shot or time distribution ▶ Identification of up to 28 emission lines in four nuclide lists; ▶ Nuclide-lists can be either created by user (based on a library) or loaded as pre-defined list ▶ Single shot or time distribution ▶ Calculation of net activity based on pre-defined or user created efficiency calibrations ▶ Energy compensated local dose rate measurement
Stabilization	Electronic temperature stabilization, peak-pickup by PSV analysis algorithm
Common	
Sampling cycles	<ul style="list-style-type: none"> ▶ Storage of up to 16 different measurement programs (defined or infinite repetition) with intervals from 1 second to weeks ▶ Predefined cycles: 10s, 30s, 60s, 5min, 15min, 1h continuous and 5min, 15min single shot
Memory	SD card to store more than 780,000 data records
Control	Touch screen 6cm x 9cm with back light, good readable even in direct sun light, shows status, results and spectra Interface: USB and NetMonitors (ZigBee)
Power supply	NiMH battery with internal charger or wall adapter (18V) Operation: min. 8 hours (14h typ.)
Size/Weight	270mm x 195cm x 210mm / 2.5kg Probe may be removed from the electronics
Software (included in delivery)	<ul style="list-style-type: none"> ▶ dVISION: device control and data transfer, visualization data export, data management, calibration, library management, export of KML files for direct opening by Google Earth™ ▶ dCONFIG: system configuration, creation of sampling cycles

NucScout

Doserate meter and nuclide identifier

NetMonitors wireless network interface (ZigBee std.)

- ▶ Frequency 2.4 GHz, power rate 100mW
- ▶ Protocol IEEE 802.15.4 (range >200m in case of intervisibility)

GPS

- ▶ SIRF 3 (12 channels), GPS coordinates are recorded and stored together with the measurement results.
- ▶ GIS compatible KML files can be exported (can be opened by Google-Earth™).

Alert indication

Buzzer 85dB, red LED, display turns on automatically

Accessory

Sampling table for usage with Marinelli beaker (standard or version with lead shield and scale), charger, USB cable, transportation case, NetMonitors network coordinator (connected via USB to PC)

poCAMon

Personal online continuous air monitor



The poCAMon (personal online continuous air monitor) combines a very compact design with a high flow rate and long battery life. Its size and weight are still acceptable for carrying by one person.

The unit measures long-lived aerosols as well as short-lived Radon daughters by alpha spectroscopy and beta counting. The radioactive aerosols and particles are collected on the surface of a high resolution membrane filter. The alpha and beta decays on the filter are measured by a high-end semiconductor radiation detector (400 mm²). This allows a perfect separation of the different decay products. The pump rate of 3 l/min is suitable for lower detection limits. The low noise rotary van pump is processor controlled and guarantees a constant flow rate over the hole measuring time. A sensor measures permanently the pressure drop on the filter in order to recognize an exhausted or perforated filter instantly.

With the 3.8 Ah NiMH battery pack the poCAMon achieves an operation time of more than 30 hours. The battery voltage is monitored and generates an alert if it is lower than an adjustable threshold. The powerful charger recharges the unit within two hours. A bright alpha numeric display and the simplified keypad (three buttons) allow the operation even under harsh conditions.

The quality control is a main issue of any radiation measurement. Therefore the poCAMon records a complete alpha spectrum for each measured value. This allows the monitoring of the device's perfect operation in each moment of the measurement.

There are options for additional sensors for carbon monoxide and combustible gases as needed in underground mines.

All measured data are stored in a 2GB memory card and can be accessed with a PC or laptop via a USB interface. Data transmission and device control can also be done via a ZigBee adapter (Net Monitors) or via a server for stationary operation with network access. A barometric pressure sensor and a GPS receiver are optional features of the device.

Because the unit is based on our DACM platform, the whole functionality of that system is available for the user (communication paths, configuration of measurement cycles, configuration etc.).

poCAMon

Personal online continuous air monitor

Aerosol Sampling Fixed on the top of the poCAMon

Detector 400mm² silicon detector,

Filter 1" high resolution membrane filter, d= 26mm, 3µm pore size, neoprene sealing for 100% tightness

- ▶ Active filter monitoring against contamination, warns in case of exhausted filter
- ▶ No tool for filter replacement required
- ▶ One month operation in "normal" environment

Pump 3 liter per Minute, low vibration, low noise rotary van pump (processor regulated)

Measurement Range Range 0 ... 1MBq/m³ (EEC)

Detection Limit The limits are given for the most radio-toxic nuclides Pu-239 and Sr-90 (without Y-90)

(Po-218) activity concentration in Bq/m ³	Alpha Exposure			
	Measuring time T = 1 min.		Measuring time T = 60 min	
	Bqh/m ³	DACH	Bqh/m ³	DACH
5	8.6	43	0.26	1.3
50	8.6	43	0.76	3.8
500	19.6	98	2.45	12.3

Detection threshold 3 σ (adjustable), detection limit 1,65 σ

(Po-218) activity concentration in Bq/m ³	Beta Exposure			
	Measuring time T = 1 min.		Measuring time T = 60 min	
	Bqh/m ³	DACH	Bqh/m ³	DACH
5	9.5	0.05	1.1	1.3
50	21	0.1	2.57	3.8
500	61	0.3	7.8	12.3

Sensitivity 0.4cpm/DACH (Pu) or 2cpm/(Bqh/m³)
2.2cpm/(Bq/m³) for Radon daughters (EEC)

Results/ Analysis

- ▶ Continuous sampling of long-lived Alpha/Beta aerosols for both Radon and Thoron daughter products
- ▶ 15 min Radon EEC grab sampling (MARKOV)
- ▶ Storage of record related spectra and time distribution

Alerts

- ▶ Dose (red flashing LED and buzzer)
- ▶ Exposure (red flashing LED and buzzer)
- ▶ High count rate (red flashing LED and buzzer)
- ▶ Filter exhausted (yellow flashing LED),
- ▶ Low battery (yellow light)

Additional Sensors	
Standard	Flow rate 0 ... 4l/min, uncertainty \pm 5%
Air analytics (optional)	CO and combustible gases, several measurement ranges available
Air pressure (optional)	Barometric pressure 800 ... 1200mbar, uncertainty 0.5% MV
Common	
Sampling	Simultaneous measurement with all detectors/ sensors with respect to the selected sampling cycle
Sampling cycles	Storage of up to 16 different sampling cycles with up to 32 steps (pre-defined or infinite repetition) Measurement interval: 1 second to several weeks
Data memory	SD card, 2 GByte
Controlling	Three buttons and bright alpha numeric display
Interface	USB, optionally wireless net monitors and network access
Power supply	Internal 12V/3.8Ah NiMH battery pack (industry standard) or AC/DC adapter/charger
Dimensions/ weight	106mm x 56mm x 200mm / 1.3kg
Software	<ul style="list-style-type: none"> ▶ dVISION: control and data transfer (also via net monitors (optional)), visualization, data management ▶ dCONFIG: system configuration, creating/changing cycles (also via net monitors (optional)) ▶ dSERVER: network access (optional)
GPS (optional)	GPS coordinates are recorded and stored together with the measurement results, GIS compatible *.kml files can be exported (can be opened by Google-Earth)
Accessories	
Standard	<ul style="list-style-type: none"> ▶ Mains power adapter ▶ USB transfer cable
Optional	Harness for comfortable carrying

Aer 5200



HV Online Air Sampler



The AER combines a beautiful design with all the requirements of a high flow radiation monitor with Radon / Thoron, alpha and beta background compensation. The instrument is trolley mounted and easy to move by one person.

The unit measures long-lived aerosols as well as short-lived Radon daughters by alpha spectroscopy and beta counting. The radioactive aerosols and particles are collected on the surface of a high resolution membrane filter. The alpha and beta decays on the filter are measured by a high-end semiconductor radiation detector (1200 mm²). This allows a perfect separation of the different decay products. The spectrometric analysis allows e.g. the detection of Plutonium aerosols which cannot be detected by measuring gamma radiation.

The pump rate (30-60l/min, adjustable) is suitable for very low detection limits. The integrated low noise rotary vane pump is processor controlled and guarantees a constant flow rate during the whole measuring time. A sensor measures permanently the pressure drop on the filter in order to recognize an exhausted or perforated filter instantly and is able to give a corresponding signal to move the filter roll to change it.

The filter roll (30 m length) can change a filter automatically when one or more of the following conditions occur:

- ▶ Every measurement cycle
- ▶ Exhausted or perforated filter
- ▶ Adjustable activity is exceeded
- ▶ Adjustable time interval has been exceeded (independent of measurement cycle)

The filter roll's step length is 7 cm, where the instrument gives an alert signal 2 step before the roll's end.

The quality control is a main issue of any radiation measurement. Therefore the Aer 5200 records a complete alpha spectrum for each measured value. This allows the monitoring of the device's perfect operation in each moment of the measurement.

Definition of local dose: A NaI detector to determine the local gamma dose is an optional feature of the device.

Toxic and explosive gases: Optionally, sensors to detect toxic and combustible gases (e.g. CO, CO₂ and CH₄) can be integrated.

All detectors can be operated simultaneously. The concept of the system allows an easy handling and a standardized data basis. The device offers predefined measurement procedures that can be easily modified by the user. Additional measurement programs can be created without any problem. The Area Aerosol Monitor disposes of a big touch-screen, showing the measured values. All measured data are stored in a 2GB memory card and are available from your PC or laptop through a USB interface. Data transmission and device control can be done by GPRS or GSM modems as well as via Net Monitors ZigBee wireless adapter, if the device is operated in inaccessible or contaminated areas.

Aer 5200

HV Online Air Sampler

Aerosol Sampling head *Fixed on the top of the Aer 5200*

Detector 1200mm² ion-implanted silicon semiconductor detector

Filter Membrane type filter (PTFE), 5µm pore size, filter roll length: 30m, width: 65mm

- ▶ Active filter monitoring against perforation, exhaustion
- ▶ No tool for filter replacement required
- ▶ More than 12 month operation in "normal" environment

Pump

- ▶ Rotary vane type 60l/min,
- ▶ processor controlled adjustable 30- 60l/min, 3
- ▶ phase 175- 260V 2,35 A, 50 Hz 0,37kW

Background Compensation Dynamic Radon background compensation using peak fitting of alpha spectrum, Gamma background compensation

Measurement Range 0 ... 1MBq/m³ (EEC)

Sensitivity

- ▶ 0.4cpm/DACH (Pu) or 2cpm/(Bqh/m³)
- ▶ 2.2cpm/(Bq/m³) for Radon daughters (EEC)

Detection Limit The limits are given for the most radio-toxic nuclides Pu-239 and Sr-90 (without Y-90).

(Po-218) activity concentration in Bq/m ³	Alpha Exposure			
	Measuring time T = 1 min.		Measuring time T = 60 min	
	Bqh/m ³	DACH	Bqh/m ³	DACH
5	0,72	3.6	0.07	0.35
50	1.78	8.9	0.23	1.13
500	5.35	27	0.99	4.92

Detection threshold 3 σ (adjustable), detection limit 1,65 σ

(Po-218) activity concentration in Bq/m ³	Beta Exposure			
	Measuring time T = 1 min.		Measuring time T = 60 min	
	Bqh/m ³	DACH	Bqh/m ³	DACH
5	2.0	0.01	0.25	0.001
50	5.6	0.03	0.71	0.004
500	10.7	0.09	2.23	0.01

Results/ Analysis

- ▶ Long-lived Alpha/Beta aerosols (Alpha Exposition, Alpha Dose, Beta Exposition, Beta Dose)
- ▶ EEC for both Radon and Thoron daughter products
- ▶ Storage of record related spectra and time distribution

Aer 5200

HV Online Air Sampler

Alert	<ul style="list-style-type: none"> ▶ Green: normal operation ▶ Yellow: filter exhausted, end of filter ▶ red + buzzer: High count rate (radioactive alert)
Additional Sensors	
Standard	<ul style="list-style-type: none"> ▶ Flow range 0 ... 200l/min, uncertainty $\pm 3\%$ ▶ Temperature -20 ... 40°C, uncertainty $\pm 0.5^\circ\text{C}$ ▶ Bar. pressure 800 ... 1200mbar, uncertainty 0,5% MW ▶ ReL Humidity 0 ...100%, uncertainty $\pm 2\%$
Air analytics (optional)	CO and combustible gases, several measurement ranges available
Air pressure (optional)	Barometric pressure 800 ... 1200mbar, uncertainty 0.5% MV
Gamma Probe (optional)	
Detector	<ul style="list-style-type: none"> ▶ Sodium-Iodid (NaI(Tl)) with integrated PMT und Bias ▶ Scintillation crystal 2" x 2" ▶ Energy range for spectroscopy 10keV – 15MeV or 25keV - 3,0MeV ▶ Spectral resolution 8% (Cs-137)
Results/ Analysis	Dose rate, Net-activity of seven user defined nuclides Storage of record related spectra and time distribution
Probe dimensions	Diameter 60mm, length 260mm
Common	
Sampling	Simultaneous measurement with all detectors/ sensors with respect to the selected sampling cycle
Sampling cycles	Storage of up to 16 different sampling cycles with up to 32 steps (pre-defined or infinite repetition) Measurement interval: 1 second to several weeks
Data memory	SD card, 2 GByte
Controlling	Touch-Screen 6 x 9 cm
Interface	USB, optionally wireless net monitors and network access
Power supply	230 VAC- 50 Hz
Dimensions/weight	1110mm x 520mm x 490mm / 54kg
Software	<ul style="list-style-type: none"> ▶ dVISION: control and data transfer (also via net monitors (optional)), visualization, data management ▶ dCONFIG: system configuration, creating/changing cycles (also via net monitors (optional)) ▶ dSERVER: network access (optional)
GPS (optional)	GPS coordinates are recorded and stored together with the measurement results, GIS compatible *.kml files can be exported (can be opened by Google-Earth)

Spectra 5011/5031 Universal Alpha/Gamma spectrometer



The SPECTRA 5011/5031 spectrometers have been developed to support companies and laboratories where radiation analysis is only one part of the work and therefore, the cost/time factor is a major aspect. But also professional radiological services will find a good solution for many purposes such as Alpha spectroscopy or Gamma spectroscopy with NaI or HPGe detectors. The set up and handling of the device is very easy. This reduces start up times and avoids mistakes at the one hand, and at the other hand, also workers without special experience are able to operate the system.

Variable detector arrangements and a lot of accessories simplify the adaptation to a wide range of various applications. For example, only a few grasps are necessary to create a lab like vacuum spectroscopy from an in situ screening system.

The input connector of the SPECTRA 50xx provides in addition the power supply and the bias voltage for the connected preamplifiers and shaping amplifiers (such as SARAD AMP01-03, MOD01-03, MOD01-04, SARAD NaI probes and THERMO FHZ type NaI probes).

The input signal is routed to a variable gain amplifier to fit the input signal to the subsequent ADC. The acquired spectrum is saved in the internal memory and can be transferred to a PC via the serial bus system. Therefore it is not necessary to keep the PC connected during the whole measurement. A maximum of 15 SPECTRA units can be simultaneously connected to this bus-system.

The SPECTRA 5011 is a portable unit and can be operated either by the internal rechargeable battery or by a mains power adapter while the 5031 comes as a 19" plug-in enclosure fitting in any 19" rack.

All set-up functions are accessible by the PC software using an USB adapter.

Spectra 5011/5031 Universal Alpha/Gamma spectrometer

Bias voltage	+35 V pre-set (model 5011) +12 .. +40 V adjustable (model 5031)
Sampled input range	0 ..2 V
Noise cut off	50 mV pre-set (model 5011) 0 .. 200 mV adjustable (model 5031)
Min. pulse rise time	5 μ s (approx. 2,5 μ s Gaussian shaping constant)
Max. pulse rise time	50 μ s (approx. 25 μ s Gaussian shaping constant)
Gain adjustment	manually, 1 to 10 linear
Max. pulse frequency	10 kS/s
ADC resolution	8 .. 12 bit
Accuracy	\pm 1,5 LSB
System dead time	72.5 μ s/pulse fixed + adjustable delay time
Spectra memory	256, 512, 1024, 2048 or 4096 channels, 32 bit wide
Sample timer resolution	0.05 s
Max. selectable sample interval	768000 s (9 days)
Min. time step	1 s
Timer accuracy	5 ppm
Power supply	internal battery or mains power adapter (5011) rear panel connector for 19" rack back plane (5031)
Battery operation	> 10 hours (model 5011)
Interface	serial CAN bus system (2 wires) with USB adapter
Dimensions	140 x 190 x 55 mm, 1.5 kg. incl. battery (5011) 14TE/3HE (model 5031)
Software	SPECTRA Control for Windows (TM) 2000/XP/Vista

VacuTube Extension for the SARAD SPECTRA 50xx MCA-series

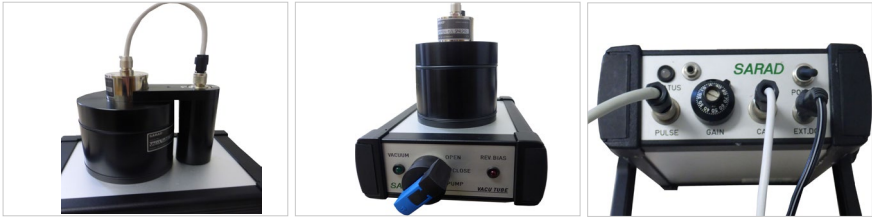

The VacuTube is a simple and cost efficient extension for the SARAD SPECTRA 50xx MCA-series to create a lab like alpha spectroscopy workbench.

The unique construction saves space at the desk and enables a comfortable access to the sample holder. Decontamination is very easy because all chamber parts can be cleaned separately.

The cap of the VacuTube has been designed to use a standard detector with Mircodot (TM) connector together with the SARAD AMP01-03 preamplifier/shaping amplifier module. Both parts can be removed from the chamber rapidly and may used in other applications too. A cross section of the chamber you will find below.

The vacuum is manually controlled by a 3-way valve, witch allows to disconnect the chamber from the pump without loosing the vacuum. The chamber is equipped with a reverse biased sample holder to avoid detector contamination and a vacuum indicator.

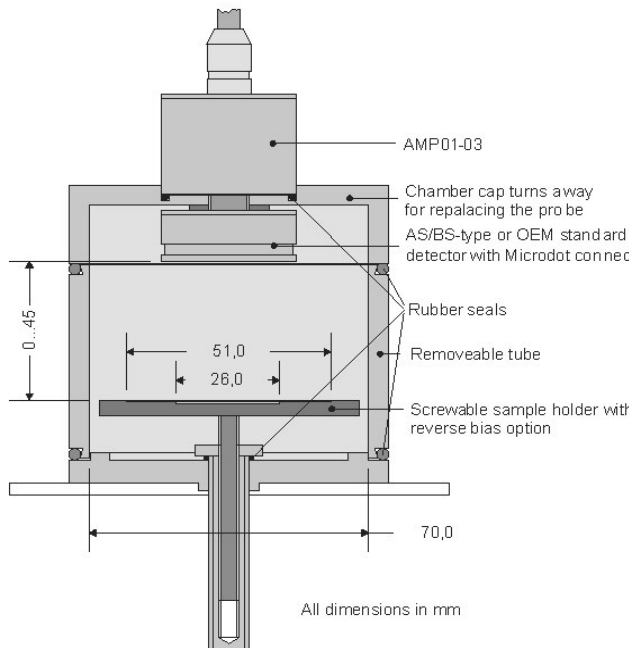

VacuTube

Extension for the SARAD SPECTRA 50xx MCA-series

Sample holder	adjustable plate for 1" and 2" dia. samples (max. 45 mm sample distance)
Detectors	standard detectors up to 2000 mm ²
Vacuum control	position valve (pump/hold/flush)
Electrical connection	mains power adapter for reverse bias
Vacuum connector	4 mm dia. quick lock connection at rear panel
Dimensions	243 x 195 x 150 mm (W x D x H)
Materials	anodised Aluminium

Detectors

Ion-implanted silicon detectors for alpha spectroscopy

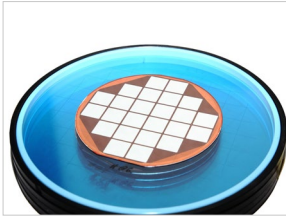

SARAD has been manufacturing ion-implanted silicon detectors for the alpha/beta spectroscopy since 1994. SARAD detectors have been proved very worthwhile a thousand times as standard detectors or in our radiation measuring equipment. Key features are their robust design, low background signal and an outstanding spectroscopic performance even at low bias voltages. Already bias voltages of 10 V enable to completely absorb the alpha radiation up to an emission energy of 10 MeV. The space-charge depletion depth detection amounts to more than 500 μm . All types can be used both under ambient conditions and in a vacuum chamber. The entrance window is provided with a passivation layer of aluminum of a thickness of 50 nm (V-type) or 500 nm (E-type). Therefore, the E types are especially suited for applications that require operation under daylight conditions. The detectors will be delivered with a Microdot connector (industrial standard) to guarantee the full compatibility with other manufacturers. As an option, the detectors can also be ordered for BNC or SMA connectors.

Type	Sensitive area [mm ²]	Housing [mm]	Height [mm]	Window [mm]	Alpha FWHM [keV] *)
AS/BS 450 V/E	450	34	13,5	22	< 18/38
AS/BS 600 V/E	600	41	13	28	< 22/42
AS/BS 900 V/E	900	48	13	34	< 27/45
AS/BS 1200 V/E	1200	55	13	39	< 35/55
AS/BS 2000 V/E	2000	67	13	50	< 40/75

*) FWHM measured in vacuum with a beam angle from 85° to 95° (collimator), Am-241 source (5.486 keV) and 35 V bias

Bias voltage ABS-Types 10 ... 100V

Depletion depth > 100 μm at 10V bias voltage
> 500 μm at bias voltage as specified in the protocol

Passivation V-Types 50 nm
 E-Types 500 nm

MOD-01/03 & 01/04 Detector modules for alpha spectroscopy



In a large number of OEM applications, Alpha- and Beta radiation detection units are required which are providing high noise immunity, simple interfacing and small form factors. The modules MOD-01/03 and MOD-01/04 offer a perfect solution for that. They combine a light-shielded, ion-implanted detector, a charge sensitive preamplifier and a shaping amplifier inside a rugged and small enclosure. Several detector sizes are available.

The Gaussian shaped output signal is perfectly suited for spectroscopy applications as well as simple counting systems.

The modules can be connected directly to our SPECTRA multi-channel analysers. In case of connection to existing NIM systems, an additional linear gain amplifier ($G = 5$) can be necessary, depending on the kind equipment.

Because of the low power requirements the units are a very good choice for battery powered instrumentation. For example, the MOD-01/04 needs only a single operation voltage between 3 and 5.5 Volts and a bias voltage between 10 and 50 Volts. For Alpha counters, both, power supply and bias can be connected to 5 Volts.

Typ	01/03 - 150	01/03 - 450	01/04 - 150	01/04 - 450
Sensitive area [mm ²]	150	450	150	450
Bias voltage [V]	10 .. 35 (5*)	10 .. 35 (5*)	10 .. 35 (5*)	10 .. 35 (5*)
FWHM (Alpha) [keV]	< 20	< 30	< 40	< 60
Pulse width [μs]	12	12	50	50
Pulse rise time [μs]	5	5	20	20
Gain [mV/MeV]	180	180	100	100
Dimensions [mm]	34 (D) x 30,5	34 (D) x 30,5	32 (D) x 13,5	32 (D) x 13,5
Supply voltage [V]	+/- 5	+3,3 .. +5,5	+3 .. +5,5	+3 .. +5,5
Current [mA]	< +/- 15	< +/- 15	< 2	< 2
Electrical connection	5-wire cable axial or radial (max. 10m)	5-wire cable axial or radial (max. 10m)	4-wire cable radial (max. 10m)	4-wire cable radial (max. 10m)

*) 5V only for Alpha gross counting, Alpha-Spectroscopy and Beta counting require at least 10V bias

Radon Scout Home

Personal home monitor



The Radon Scout Home is used for long-term monitoring of the legal reference value for the radon concentration in breathing air. The device was specially designed for homeowners as well as tenants, lessors and housing companies.

The Radon Scout Home records the transient behaviour of the radon concentration over many years reliably, meaning that influences on weather conditions and seasonal changes are safely recorded.

The instrument measures the dangerous rare gas Radon as well as CO₂ - the most important indication for the air quality **).

Thus, the user can check whether the statutory limits *) for Radon are exceeded or not and at the other hand the instrument signalizes immediately when a room should be ventilated. To prevent mould formation, temperature and humidity are monitored additionally. The measurement data can be read out at any time for preservation of evidence.

Use the Radon Scout Home at home, in your office, in schools and everywhere you are to ensure a healthy environment. Just place the unit on your desk, like a smart clock.

*) The radioactive noble gas radon counts as the major cause of lung cancer besides smoking. Because of this, a maximum of 300 Bq/m³ will be defined until 2018 by European law. Radon gets from ground or construction materials into buildings and leads to higher concentrations depending on availability and air exchange.

**) The German limit for the CO₂ indoor concentration is 1500 ppm. A concentration below 1000 ppm is inoffensive while the range between 1000 ppm and 2000 ppm results in reduced personal performance. Concentrations above 2000 ppm are not acceptable.

Principle of operation

- ▶ Radon: Silicon detector and Alpha spectroscopy
- ▶ CO₂: Non-dispersive infrared (NDIR)

Range

- ▶ Radon: 0...10.000.000 Bq/m³
- ▶ rel. Humidity: 0%rF ... 100%rF
- ▶ Temperature: - 40°C ... 120°C
- ▶ Pressure: 760 mbar ... 1200 mbar
- ▶ CO₂: 0ppm ... 5000ppm (0% ... 0.5%)

Accuracy

- ▶ Radon: < 2%
- ▶ rel. Humidity: < 4.5% (3% typ.) for 20% ... 80%rF
- ▶ Temperature: < 0.4°C (0.3°C typ.) for 5°C ... 60°C
- ▶ Pressure: < 0.5% FSO
- ▶ CO₂: < 5% ± 50ppm

Sensitivity (Radon) 5.52 cph/(kB/m³)

Radon Scout Home

Personal home monitor

Stat. Error (1σ) (Radon)	<ul style="list-style-type: none"> ▶ 1 week @ 300 Bq/m³.....6% ▶ 1 month @ 300 Bq/m³.....3% ▶ 1 week @ 100 Bq/m³.....10% ▶ 1 month @ 100 Bq/m³.....5% ▶ 24 hours @ 300 Bq/m³.....15%
Response time (CO₂)	10 min
Remark (CO₂)	CO ₂ sensor works only when instrument is powered through USB connector (computer, AC/DC adapter, power bank); measurement of other parameters are not affected. Automatic calibration with respect to outdoor CO ₂ level
Environmental conditions	-10°C ... 50°C, 0% rF ... 99%rF (no condensation)
Power supply	2 x AAA battery or USB socket, Battery operation approx. 5 ... 6 months. Low battery indication by red LED, Short time buffering of real time clock during battery replacement.
Data storage	Non-volatile memory with circular structure for 16383 data records in any number of test series. Saves all parameters including tilt detection each four hours
Alert indication	Red backlight will be lighted if the CO ₂ concentration exceeds the threshold of 1000ppm (Radon Scout Home – CO ₂ only)
Interface	USB (mini USB socket)
Operation	Slide switch to start/stop sampling; Button to toggle display page and backlight
Display	Alpha numeric LCD with bright backlight; Units can be changed between SI and US style; English, German, French and Spanish versions available; date and time; Radon average since start of a measurement series; Radon average of previous 24 hours; Temperature, rel. humidity; Bar. Pressure (Radon Scout Home – P only), CO ₂ concentration (Radon Scout Home – CO ₂ only), Battery voltage (Radon Scout Home – P/CO ₂ only)
Software / Accessory	Radon Vision, USB cable (incl. for all models); NAC/DC adapter (incl. for models with pressure or CO ₂ sensor); Power bank (option for mains power independent operation with CO ₂ sensor); Factory calibration with certificate (opt.) DKD calibration with certificate (opt.)
Dimensions	80mm x 96mm x 44mm
Weight	140g including batteries

DOSEman

Radon Exposimeter/Dosimeter



The DOSEman was developed as a personal Radon dosimeter within a project of the German Federal Office of Radiation Protection. The instrument is suitable for measurements of Radon activity concentration in the air as well as determination of the dose.

It has been tested under harsh conditions in the mining industry.

The small outlines, the light weight and its roughness allowing a stress-free permanent wearing of the instrument.

The integrated rechargeable batteries are good for approximately 12 days continuous operation. The instrument is absolute tamper-proof and can be operated by a single push button.

A short response time realised by the built in Alpha spectroscopy makes sure that the person who wears the dosimeter will be warned immediately in case of dangerous Radon concentrations. The internal data memory was designed large enough to save a high-resolution time distribution. A special infrared adapter is required to download the data from the DOSEman to the PC.

Beside the usage as a dosimeter the instrument is very often used as an universal monitor. Because of the small measurement chamber and the resultant lower sensitivity, some limitations have to be accepted. But for many applications the DOSEman could be still a good compromise. Measurements over few ours up to several days will deliver respectable results even at low Radon levels. Soil gas sampling can be performed using very simple accessory.

For long term measurements we generally recommend the Radon Scout. If low concentrations or small concentration steps shall be detected as soon as possible, the usage of the RTM1688-2 should be preferred.

The Radon Scout comes with the latest release of the Radon Vision software.

DOSEman

Radon Exposimeter/Dosimeter

Theory of operation	<ul style="list-style-type: none"> ▶ HV biased measurement chamber with diffusion membran for air inlet ▶ Electrostatic collection of Radon daughters generated by Radon decay within the chamber on the surface of a semiconductor detector ▶ Spectroscopic analysis of collected short living Radon daughter products
Measurement range	0 ... 4 MBq/m ³
Response time	12/120 minutes to 95% of the final value)
Sensitivity	0.18/0.32 Counts/Minute @ 1000 Bq/m ³ (fast/slow mode) <ul style="list-style-type: none"> ▶ 20% statistical error (1) @ 200 Bq/m³ within 8 hours (slow mode) ▶ 10% statistical error (1) @ 200 Bq/m³ within 24 hours (slow mode) ▶ 16% statistical error (1) @ 1000 Bq/m³ within 2 hours (slow mode)
Sample interval	1 ... 255 minutes, adjustable by software
Memory	Non volatile data memory to store 720 data records and sum spectrum
Clock	Internal real time clock
Power supply	Internal rechargeable battery for 12 days permanent operation 2 hours recharge time
Operation	<ul style="list-style-type: none"> ▶ Control by a single push button, ▶ Optical and audible alert ▶ Displaying of concentration, e ▶ xposure and dose (LCD, 3 lines x 12 characters)
Protection class	IP 65
Dimensions/Weight	115 x 57 x 32 mm, weight 250 g
Interface	Infrared interface , spezial IR – USB adapter is required
Software	Data transfer, set-up and instrument control by Radon Vision software

DOSEman PRO

Radon daughter product Dosimeter



The DOSEman PRO was developed as a personal dosimeter to determine the exact exposure obtained by the short living Radon daughter products (progeny) (EEC) in the air. This project was initiated by the German Federal Office of Radiation Protection (BfS). The instrument is also qualified for the continuous measurement of Radon progeny concentration.

In combination with a Radon monitor (like RTM1688-2), an inexpensive system for Equilibrium Factor measurements is offered.

Dimensions and weight were designed to ensure the mobility of the wearer of the instrument. The internal rechargeable battery allows an autonomous operation of more than 40 hours. Due to the optimised sampling aperture, no other maintenance is required than a monthly filter replacement (continuous operation at normal dust pollution).

The display can be toggled between the "Potential Alpha Energy Exposure (PAEE)", the equivalent dose and the current concentration levels, PAEC as well as "Equilibrium Equivalent Radon Concentration (EEC)". The dose calculation is based on an user defined dose conversion coefficient. If the dose value exceeds an adjustable limit, an audible alert will be activated.

The instrument is tamper-proof – several programmable codes are provided to assign the acquired data to a person or location later on.

The time distribution of the Radon daughter product concentration is stored in a non-volatile memory and can be transferred to a PC by the infrared interface. A special infrared adapter with USB connection is required.

The instrument will be shipped with the latest version of the Radon Vision software.

DOSEman PRO

Radon daughter product Dosimeter

Theory of Operation	Collection of the Radon daughter products at the surface of a filter by a continuous air flow permanent alpha spectroscopic analysis of the filter
Filter	0.3 µm Membrane filter (PTFE) Diameter 17.5 mm 1 month replacement interval under normal conditions
Pump	Membrane pump 0.18 Lpm
Sensitivity	approx. 150 cpm @ 1000 Bq/m ³ (EEC)
Response time	2 hours (to 90% of the final value)
Integration interval	1 ... 255 minutes, adjustable in 1 Minute steps
Operation	Single push button with „Lock“ function
Display	3 x 12 characters, either US or SI units
Alert	Acoustic
Memory	377 records and sum spectrum, non-volatile
Interface	Infrared data link with special adapter for the USB-Port of the PC
Power supply	internal rechargeable battery <ul style="list-style-type: none"> ▶ approx. 48 hours continuous operation ▶ Charging time approx. 2 hours
Housing	rough Aluminium enclosure with open sampling head
Dimensions	▶ 138 x 57 x 32 mm
Weight	▶ 300g
Software	Radon Vision

EQF 3200

Radon/Thoron gas and daughter product monitor system



The EQF 3200 is the ideal monitor to evaluate the availability of radon and its expected dose. The device defines the concentration of gas and decay products for Radon and Thoron, in order to calculate the equivalent factor.

The EQF 3200 is equipped with instrument grade semiconductor radiation detectors, both in the radon measurement chamber and the sampling head for the decay products. This allows a perfect separation of the different decay products of radon, using alpha-spectroscopy. The fine pored membrane filter of the newly developed sampling head is exchangeable with no need of any tool. The reinforced filter is used in combination with an automatically controlled rotary vane pump that guarantees a constant air flow through the filter. A sensor measures permanently the air pressure over the filter in order to recognize instantly an exhausted or perforated filter.

The measurement chamber works following the principle of high-voltage collection and has, despite its low volume, an extraordinary sensitivity. This means a decisive advantage when it comes to measuring small thoron probe volumes. The long-term contamination by the increasing Po-210 underground that appears in other measurement principles is completely annulated by alpha spectroscopy. There is no cross-sensitivity regarding the ambient radiation. The chamber is immune to humidity changes of the environment. This is why a drying cartridge, as needed in other devices working following the principle of high-voltage collection, is not necessary in the EQF 3200.

The quality control is a main issue of any radiation measurement. Therefore the EQF 3200 records a complete alpha spectrum for each measured value. This allows controlling the perfect functioning of the instrument in each moment of the measurement.

The EQF 3200 disposes of a big touch-screen, showing the measured values. All measured data are stored in a 2GB memory card and are available from your PC or laptop through a USB interface. Data transmission and device control can be done by GPRS or GSM modems, as well as via ZigBee adapter (Net Monitors wireless network). A NaI detector to fix the local gamma dose is an optional feature of the device. The EQF 3200 disposes of additional input and output terminals to connect sensors and actuators according to client-specific needs. The data sheet shows some examples.

EQF 3200 Radon/Thoron gas and daughter product monitor system

Radon chamber

Detector	4 x 200mm ² ion-implanted silicon detector
Internal volume	250mm ³ (total volume of the internal air loop)
Measurement range	0 ... 10 MBq/m ³
Sensitivity	3 / 7 cpm/(kBq/m ³) for fast / slow mode
Response time	12 / 120 min for fast / slow Mode
Results / Analysis	Radon concentration fast(excl. Po-214) and slow (incl. Po-214) Thoron concentration Storage of record related spectra and time distribution

RDP sampling head *Fixed at the front panel of the EQF 3200*

Detector	400mm ² ion-implanted silicon detector
Filter	Membrane filter, d=27mm, 1µm pore size <ul style="list-style-type: none"> ▶ Active filter monitoring against perforation, exhaustion ▶ No tool for filter replacement required

Pump Rotary vane type 1,65 l/min, processor controlled

Measurement range	0 ... 1 MBq/m ³ (EEC)
Sensitivity	Approx. 600 cpm/(kBq/m ³) (EEC)
Response time	120 min
Results / Analysis	EEC, PAEC for both, Radon und Thoron Storage of record related spectra and time distribution

Gamma probe (option) *Connected to the front panel of the EQF 3200 by cable*

Detector	Sodium-Iodid (NaI(Tl)) with integrated PMT und Bias <ul style="list-style-type: none"> ▶ Scintillation crystal 2" x 2" ▶ Energy range for spectroscopy 10keV – 1,5MeV ▶ or 25keV - 3,0MeV ▶ Spectral resolution 8% (Cs-137)
-----------------	---

Results / Analysis Dose rate, Net-activity of seven user defined nuclides
Storage of record related spectra and time distribution

Probe dimensions Diameter 60mm, length 260mm
Cable 5m (optional 10m)

Additional sensors

Standard	Rel. Humidity 0 ...100%, uncertainty ± 2% Temperature -20 ... 40°C, uncertainty ± 0.5°C Bar. pressure 800 ... 1200mbar, uncertainty 0,5% MW Flow rate 0 ... 4 l/min, uncertainty ± 5%
-----------------	--

EQF 3200

Radon/Thoron gas and daughter product monitor system

Air analytics (option)	CO, CO ₂ , CH ₄ , combustible gases, several ranges
Water analytics (option)	pH value, Redox potential, conductivity etc.
Process (option)	Pressure, differential pressure, flow, velocity etc.
Meteorological (option)	Wind direction, wind speed etc
Common	
Sampling	Simultaneous measurement with all detectors/sensors with respect to the selected sampling cycle
Sampling cycles	Storage of up to 16 different sampling cycles with up to 32 steps (pre-defined or infinite repetition) Interval 1 Second to several weeks
Data memory	SD Card, 2 GByte
Controlling	Touch-Screen 6 x 9cm
Interface	USB, RS232, Net Monitors wireless optionally
Power supply	Internal 12V rechargeable battery, mains power adapter Optionally additional connector for 12V car battery or solar power supply
Dimensions/weight	235mm x 140mm x 255mm / 6kg
Software	<ul style="list-style-type: none">▶ dVISION: Control and data transfer (also via GPRS, GSM, Zig-Bee), visualization, data management▶ dCONFIG: system configuration, creating/changing cycles (also via GPRS, GSM, ZigBee)▶ dLIBRARY: Library for NaI gamma probe (option)
Extensions	Available at internal connectors: <ul style="list-style-type: none">▶ 8 analogous inputs,▶ 3 counter inputs,▶ 2 status inputs,▶ 6 switch outputs,▶ clock switch,▶ PID regulator/analogous output
GPS (option)	GPS coordinates are recorded and stored together with the measurement results. GIS compatible *.kml files can be exported (can be opened by Google-Earth). Antenna connected by cable.

EQF 3220

Particle size specific Rn/Tn gas & daughters monitor



Within our range of portable monitors for Radon and its decay products, the EQF 3220 is our high-end instrument. It contains all components that are needed for the complex scientific evaluation of a local radon situation. It allows measuring the activity concentration not only of Radon and Thoron gas but also of their decay products (EEC), in relation with particle size distribution. The instrument samples free and attached decay products as well as the cluster component within the range of 20 to 100 nm. This component appears commonly during combustion processes in the air.

The small aerosol sampling head can be removed from the device and placed in any other part of the room. The fine pored membrane filter of the newly developed sampling head is exchangeable with no need of any tool. The filter has a reinforced membrane fiber and an automatically controlled rotary vane pump that guarantees a constant air flow through the filter. A stainless steel mesh is employed to separate the free decay products. Several tests have shown an excellent reliability of the measurement results. The EQF 3220 is equipped with high-end semiconductor radiation detectors, both in the Radon measurement chamber and the detection head for the decay products. This allows a perfect separation of the different decay products of Radon, using alpha-spectroscopy.

The measurement chamber works following the principle of high voltage collection and has, despite its low volume, an extraordinary sensitivity. This means a decisive advantage when it comes to measuring Thoron or small probe volumes. The long-term contamination that appears in other measurement principles by the increasing Po-210 underground is completely annulated. There is no cross-sensitivity regarding the ambient radiation. The chamber is immune to humidity changes of the environment. This is why a desiccation cartridge, as needed in other devices working following the principle of high voltage collection, is not necessary in the EQF 3220. The quality control is a main issue of any radiation measurement. Therefore the EQF 3220 records a complete alpha spectrum for each measured value. This allows controlling the perfect operation of the device in each moment of the measurement.

The EQF 3220 disposes of a big touch-screen, showing the measured values. All measured data are stored in a 2GB memory card and are available from your PC or laptop through a USB interface. Data transmission and device control can be done by GPRS or GSM modems, as well as via ZigBee adapter (Net Monitors). A NaI detector to measure the local gamma dose and a GPS receiver are optional features of the device. The EQF 3220 disposes of additional input and output terminals to connect sensors and actuators according to client-specific needs. The data sheet shows some examples.

EQF 3220

Particle size specific Rn/Tn gas & daughters monitor

Radon chamber	
Detector	4 x 200mm ² ion-implanted silicon detector
Internal volume	250mm ³ (total volume of the internal air loop)
Measurement range	0 ... 10 MBq/m ³
Sensitivity	3 / 7 cpm/(kBq/m ³) for fast / slow mode
Response time	12 / 120 min for fast / slow Mode
Results / Analysis	Radon activity concentration fast(excl. Po-214) and slow (incl. Po-214) Thoron activity concentration Storage of record related spectra and time distribution
Aerosol sampling head	<i>Telescopic mounting on the instrument enclosure, removeable</i>
Dimensions	Diameter 44mm, Length 100mm
Detectors	2 x 150mm ² ion-implanted silicon detector
Filter	Membrane type filter, d=27mm, 1µm pore size Active filter monitoring against perforation, exhaustion No tool for filter replacement required
Screen	Stainless steel grid , d = 15mm
Pump	Rotary vane type 1,65 l/min, processor controlled
Measurement Range	0 ... 1 MBq/m ³ (EEC) attached/unattached
Sensitivity	Attached decay products approx. 600 cpm/(kBq/m ³) (EEC) Unattached decay products approx.150 cpm/(kBq/m ³) (EEC)
Response time	120 min
Results/Analysis	EEC, PAEC for attached and unattached Radon and Thoron daughter products Storage of record related spectra and time distribution
Gamma probe (option)	<i>Connected to the front panel of the EQF 3220 by cable</i>
Detector	Sodium-Iodid (NaI(Tl)) with integrated PMT und Bias <ul style="list-style-type: none">▶ Scintillation crystal 2" x 2"▶ Energy range for spectroscopy 10keV – 1,5MeV▶ or 25keV - 3,0MeV▶ Spectral resolution 8% (Cs-137)
Results / Analysis	Dose rate, Net-activity of seven user defined nuclides Storage of record related spectra and time distribution
Probe dimensions	Diameter 60mm, length 260mm Cable 5m (optional 10m)
Additional Sensors	

EQF 3220

Particle size specific Rn/Tn gas & daughters monitor

Standard	<ul style="list-style-type: none"> ▶ Rel. Humidity 0 ...100%, uncertainty $\pm 2\%$ ▶ Temperature -20 ... 40°C, uncertainty $\pm 0.5^\circ\text{C}$ ▶ Bar. pressure 800 ... 1200mbar, uncertainty 0,5% MW ▶ Flow rate 0 ... 4 l/min, uncertainty $\pm 5\%$
Air analytics (option)	CO, CO ₂ , CH ₄ , combustible gases, several ranges
Water analytics (option)	pH value, Redox potential, conductivity etc.
Process (option)	Pressure, differential pressure, flow, velocity etc.
Meteorological (option)	Wind direction, wind speed etc.
Common	
Sampling	Simultaneous measurement with all detectors/sensors with respect to the selected sampling cycle
Sampling cycles	Storage of up to 16 different sampling cycles with up to 32 steps (pre-defined or infinite repetition) Interval 1 Second to several weeks
Data memory	SD Card, 2 GByte
Controlling	Touch-Screen 6 x 9cm
Interface	USB, RS232, optionally Net Monitors wireless
Power supply	Internal 12V rechargeable battery, mains power adapter Optionally additional connector for 12V car battery or solar power supply
Dimensions/weight	235mm x 140mm x 255mm / 6kg
Software	dVISION: Control and data transfer (also via GPRS, GSM, Net Monitors), visualization, data management dCONFIG: system configuration, creating/changing cycles (also via GPRS, GSM, Net Monitors) dLIBRARY: Library for NaI gamma probe (option)
Extensions	Available at internal connectors: 8 analogous inputs, 3 counter inputs, 2 status inputs, 6 switch outputs, clock switch, PID regulator/analogous output.
GPS (option)	GPS coordinates are recorded and stored together with the measurement results. GIS compatible *.kml files can be exported (can be opened by Google-Earth). Antenna connected by cable.
Accessory	
Standard	<ul style="list-style-type: none"> ▶ Mains power adapter ▶ USB transfer cable ▶ Serial transfer cable
Option	<ul style="list-style-type: none"> ▶ Gas dryer (Peltier-cooler) for stationary water sampling ▶ Soil gas Kits (pile drive probe or packer probe) ▶ Exhalation bonnet ▶ Radon in water kit

Radon Scout / Plus

Indoor Radon monitor



The Radon Scout was developed to meet the special requirements of long term measurements inside Radon affected properties. Attention was paid for easy operation as well as for protection against unauthorised manipulation.

Due to their outstanding sensitivity, Radon Scout and Radon Scout Plus are fast enough to control ventilation equipment by a potential-free switch contact. As accessory, we offer a set of wireless switch to be directly connected to the instrument and a radio controlled mains socket. Thus, exhausters like kitchen hoods, wall or window ventilators anywhere in your home can be remote controlled.

Two standard D-size cells enable an autonomous operation over a few month. The Radon Scout PLUS offers an additional connection for an external power supply. In fact, this allows an operation over infinite time periods.

The size of the data memory was designed to get a high-resolution time distribution. Any number of measurement series may be created. The acquired data can be loaded by a PC even if a measurement is in progress. The instrument can be directly connected to a modem (analogue, ISDN, GSM) for remote data transmission. The Radon Vision software (included in delivery) handles the telephone connection as simple as a direct cable link.

Because of the high sensitivity, variations of the activity concentration will be detected accurately even in case of low Radon levels. The instrument works in diffusion mode so that a possible influence of Thoron can be excluded. The measurement chamber, equipped with a semiconductor detector and high voltage collection, shows no sensitivity against ambient humidity.

Sensors for temperature and humidity (barometric pressure in addition in case of Radon Scout PLUS) are very useful add-ons. The integrated tilt detector will give a signal if the instrument was moved from its original position during the measurement.

For fast spot measurements at low Radon levels we recommend to use the RTM1688-2. If the expected concentrations are sufficient high, also the DOSEman is a good choice.

Due to their outstanding sensitivity, Radon Scout and Radon Scout Plus are fast enough to control ventilation equipment by a potential-free switch contact. As accessory, we offer a set of wireless switch to be directly connected to the instrument and a radio controlled mains socket. Thus, exhausters like kitchen hoods, wall or window ventilators anywhere in your home can be remote controlled. Even older instruments of the Radon Scout series can be upgraded with the required switch contact. The switching threshold for the Radon Scout is fixed to the EU target value of 300 Bq/m³ whilst the Radon Scout PLUS allows user specific settings.

Solve your Radon problem efficiently, at low cost and negligible effort!

Radon Scout

Indoor Radon monitor

Measurement Range	0 ... 10 MBq/m ³
Sensitivity	<ul style="list-style-type: none"> ▶ 1.8 cpm @ 1000 Bq/m³ (independent on the humidity) ▶ 200 Bq/m³ with 20% statistical error (1s) at 1 hour interval ▶ 1000 Bq/m³ with an statistical error (1s) < 10 % at 1 hour interval ▶ 100 Bq/m³ with 17% statistical error (1s) at 3 h interval
Response Time	120 minutes to 95% of the final value
Internal Sensors	<ul style="list-style-type: none"> ▶ Relative humidity (0 .. 100%) ▶ Temperature (-20 .. 40°C) ▶ Tilt
Integration interval	1 hour and 3 hours or customised <ul style="list-style-type: none"> ▶ Non volatile storage of the last 640 data records ▶ Internal real time clock
Power supply	2 x D-size cell (NiCd, NiMH or Alkaline) Battery operation > 90 days
Switch output	Switch output for ventilation control
Control	by a single switch, measurement/stand-by (lock-function)
Dimensions/Weight	175 x 135 x 55 mm, 800 g (incl. Battery)
Radon Vision Software included	<ul style="list-style-type: none"> ▶ Set-up, data download (also via modem – analogue line, ISDN, GSM) ▶ Interactive graphical display (zoom, pan, fit data-cursor, marker for tilt and start of a new measurement, error bars, smoothing) ▶ Selective ASCII export (EXCEL format) ▶ Selective graphical protocol print (space for individual header, user comments) ▶ Calculation of average concentration and exposure ▶ Automatic created file names and path structure ▶ Switch over between US and SI-units (Bq/m³/pCi/L) ▶ Also available with display and more additional features (Radon Scout PLUS)

Radon Scout Plus

Indoor Radon monitor

Measurement Range	0 ... 10 MBq/m ³
Sensitivity	1.8 cpm @ 1000 Bq/m ³ (independent on the humidity) 200 Bq/m ³ with 20% statistical error (1s) at 1 hour interval 1000 Bq/m ³ with an statistical error (1s) < 10 % at 1 hour interval 100 Bq/m ³ with 17% statistical error (1s) at 3 h interval
Response Time	120 minutes to 95% of the final value
Internal Sensors for	<ul style="list-style-type: none">▶ Relative humidity (0 ... 100%)▶ Temperature (-20 ... 40°C)▶ Barometric pressure (800 ... 1200 mbar)▶ Tilt
Integration interval	1 .. 255 minutes adjustable by software, Internal real time clock
Memory	Non volatile storage of the last 16363 data records
Power supply	<ul style="list-style-type: none">▶ 2 x D-size cell (NiCd, NiMH or Alkaline) and mains power▶ Battery operation > 90 days▶ Control by a single switch, measurement/stand-by (Lock-function)▶ 3 x 16 characters display with back-light (US/SI units selectable by software)
Switch output	Switch output for ventilation control
Dimensions/Weight	175 x 135 x 55 mm, 800 g (incl. Battery)
Radon Vision Software included	Set-up, data download (also via modem – analogue line, ISDN, GSM) <ul style="list-style-type: none">▶ Interactive graphical display (zoom, pan, fit data-cursor, marker for tilt and start of a new measurement, error bars, smoothing)▶ Selective ASCII export (EXCEL format)▶ Selective graphical protocol print (space for individual header, user comments)▶ Calculation of average concentration and exposure▶ Automatic created file names and path structure▶ Switch over between US and SI-units (Bq/m³/pCi/L)

Thoron Scout

Radon & Thoron measurements



The instrument allows the simultaneous activity concentration measurement of Radon ($Rn222$) and Thoron ($Rn220$) based on a diffusion type measurement chamber.

The required fast exchange rate of sampled air is realized by a highly permeable chamber placed outside the instruments enclosure. The relative Thoron sensitivity is comparable with the one of pump based instruments.

The modified measurement chamber has been derived from the Radon-Scout while the electronics come from the RTM1688-2. That means, more than 2000 data records including a complete alpha spectrum can be stored. Of course, sensors for barometric pressure, temperature and humidity are integrated too.

The Thoron Scout offers a larger Display compared with the Radon Scout. The replaceable batteries allow an autonomous operation of approximately one month. It is possible to operate the unit by mains power resulting in unlimited sampling periods.

There is also a switch output which can be used for alert purposes or to control ventilation equipment.

Due to their outstanding sensitivity, Radon Scout and Radon Scout Plus are fast enough to control ventilation equipment by a potential-free switch contact. As accessory, we offer a set of wireless switch to be directly connected to the instrument and a radio controlled mains socket. Thus, exhausters like kitchen hoods, wall or window ventilators anywhere in your home can be remote controlled. Even older instruments of the Radon Scout series can be upgraded with the required switch contact. The switching threshold for the Radon Scout is fixed to the EU target value of 300 Bq/m^3 whilst the Radon Scout PLUS allows user specific settings.

Solve your Radon problem efficiently, at low cost and negligible effort!

Thoron Scout

Radon & Thoron measurements

Measurement Range	<p>▶ 0 ... 10 MBq/m³</p> <p>Optimized high voltage measurement chamber with electrostatic collection of Radon progenies generated inside the chamber on a semiconductor detector</p>
Sensitivity	<ul style="list-style-type: none">▶ doubling of sensitivity for Radon in slow mode through inclusion of Po-214▶ no contamination with long-living radon progenies▶ no influence of humidity on sensitivity▶ high sensitivity with small chamber volume (only ca. 60 ml)▶ Thoron: 0.42 cpm@kBq/m³, for Radon: 0.85/1.50 cpm@kBq/m³ (fast/slow mode)▶ Thoron: 200 Bq/m³ with 25% statistical error (1) at 4h measurement interval
Response Time	<p>Spectrometric analysis of short-living Thoron and Radon progenies measurement of Thoron (Rn-220) concentration fastest possible response time: immediately for Thoron, 95% of the final value after 12 minutes in fast mode for Radon</p>
Internal Sensors for	<p>relative humidity (0 ... 100%) temperature (-20 ... 40°C) barometric pressure (800 ... 1200mbar) movement</p>
Integration interval	<ul style="list-style-type: none">▶ 1 minute to 4 hours adjustable in minute increments, Integrated real time clock▶ 100% quality assurance through output of alpha spectrum for each interval
Memory	<p>Non-volatile memory for 2047 data records, each incl. alpha spectrum</p>
Interface	<p>RS232 and USB interface for set-up or data transfer (GSM, ZigBee connectable)</p>
Control	<ul style="list-style-type: none">▶ Backlit display (4 lines x 20 characters)▶ Controllable by a single switch, measurement/stand-by (lock-function)▶ Measurement principle: diffusion (no moving parts e.g. pump)▶ Internal buzzer for alert function and Radon-„Sniffing“
Dimensions/ Weight	<p>175 mm x 135 mm x 90 mm, 1.1 kg (incl. batteries)</p>
Power supply	<p>2 x D-size cell, NiCd, NiMH or Alkaline and mains power Operation time of battery: > 30 days</p>
Software	<p>RadonVision Software</p>

Radon Scout PMT

Radon monitor with Lucas cell



If a large number of Radon samples shall be taken within a short time for later analysing, the Radon Scout PMT is the preferable choice. One typical application is the geological investigation of new Uranium fields.

The instrument uses a replaceable scintillation chamber (Lucas cell) to convert the radiation into light pulses detected by a photo multiplier tube (PMT). An outstanding low detection limit for that measurement principle is obtained by the continuous signal shape analysis. Practically, the electronic background of the PMT will be removed completely.

The Lucas cells can either be filled separately on site, or operated in flow through mode as a continuous Radon monitor. The built in sampling pump can be manually switched on and of. Three different chamber sizes are available. Sensors for temperature, humidity and barometric pressure are very useful add-ons.

The internal memory is big enough to store more than 2000 data records. All acquired data can be loaded by a PC even if a measurement is in progress. The instrument can be directly connected to a modem for remote data transmission. The Radon Vision software (included in delivery) handles the telephone connection as simple as a direct cable link. Two replaceable standard D-size cells enable an autonomous operation over a few days. An external power supply allows an operation over infinite time periods.

The Lucas cell offers an outstanding sensitivity compared with other principles. Collected probes can be analysed in a very short time with high accuracy. There is no influence of humidity and temperature. If Thoron (Rn-220) is available in the sampled air, or if short concentration steps shall be measured, or very small quantities of Radon must be detected, we recommend the use of our RTM1688-2.

Radon Scout PMT

Radon monitor with Lucas cell

Theory of operation	Replaceable scintillation chamber (Lucas cell)
Chamber	Chamber volume: 80 ml, 160 ml or 240 ml <ul style="list-style-type: none">▶ Connection to the PMT by push/pull mechanism▶ 2 quick lock connectors for 6 mm tubes
PMT	72 mm (diameter) entrance window Background < 0.01 counts/Minute (cpm)
Measurement Range	0 ... 10 MBq/m ³
Sensitivity	approx. 12cpm (80ml)/ 22cpm (160ml)/ 30cpm (240ml) @ 1000 Bq/m ³
Detection limits (MDA)	2 Bq/m ² (240 ml chamber)
Response time (95%)	120 minutes
Pump	Membrane type approx. 0,25 L/min, manual switch
Internal sensors	Relative humidity (0 ... 100 %) Temperature (-20 ... 40 °C) Barometric pressure (800 ... 1200 mbar)
Sample interval	1.. 255 minutes adjustable by Software, Integrated real time clock
Data storage	2047 data records (non-volatile, circular architecture)
Power supply	2 x Mono cell (D size), replaceable, NiCd, NiMH, Alkaline or mains power adapter (included in delivery)
Battery operation	> 10 days (Alkaline battery without pump) > 4 days with continuous pumping
Control	Toggle switch Run/Stop with lock function <ul style="list-style-type: none">▶ Display 3 x 16 characters (US/SI units) with back-light▶ Current Radon; Humidity; Temperature; Pressure; Battery;▶ Radon average since last start; Total time;▶ Counts per Minute; counts per Interval; Selected cell size
Interface	RS232 for PC, modem Pulse output (option)
Dimensions/ Weight	232 x 182 x 135 mm (without handle) 3.5 kg
Software	Radon Vision (included in delivery)
Accessory	Lucas cells, hard case, portable vacuum pump

Indoor Air Sensor Stationary Radon monitor & transmitter

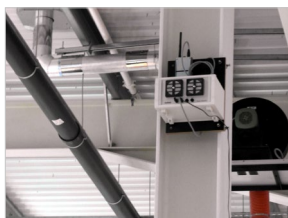

The Indoor Radon Sensor was especially fitted to the needs of indoor air quality monitoring (IAQ) and building automation. The wall mounted enclosure covers a high sensitive Radon chamber as well as sensors for temperature and humidity.

The sampled air enters the Radon chamber by diffusion. As an option, a version with an internal pump is available to take samples from ventilation ducts or closed loops.

The Radon concentration calculated for an adjustable counting interval will be converted to an analogous signal (either 0 ... 1V or 0 ... 20mA). This allows to integrate the sensor into existing automation systems very easily.

The upper range value can be assigned by software according the local requirements. In addition to the analogous ports a digital output (open drain) is available which can be used either for alert generation or for direct counting of the nuclear decay events (nuclide specific). The unit contains an independent data logger to store 344 records and the sum spectrum for "stand alone" solutions.

The recent sensor readings can be recalled via the serial interface (RS232) by a PC even if a sample is running. The required transfer protocol is provided by SARAD on demand. After an interruption of the power supply (10.8 to 14.2 VDC) the sensor will restart automatically.

The unit is shipped with the latest version of the Radon Vision software.

Indoor Air Sensor

Stationary Radon monitor & transmitter

Theory of operation	High voltage chamber with semiconductor detector	
Sampling	Diffusion or internal pump (option)	
Sensitivity	3/7 counts/min @ 1000 Bq/m ³ (fast/slow)	
Response time	15/120 minutes (fast/slow)	
Measurement Range	Radon	0 ... 10 MBq/m ³
	Temperature	0 ... 70 °C
	Humidity	0 ... 100%
Enclosure	▶ Material- Aluminium (powder coated), wall mounting possible	
Dimensions/Weight	225 mm x 145 mm x 180 mm (Width x Height x Depth) 2000 g	
Integration interval	1 ... 255 minutes adjustable in 1 Minute steps	
Radon calculation	Alpha spectroscopy	
Memory	344 data records and sum spectrum, non-volatile	
Interface	▶ Analogues- 2 x 0 ... 1V or 0 ... 20mA (1024 steps) either Radon/Thoron OR temperature/humidity *) upper range value programmable ▶ Digital- Open drain with internal pull-up resistor (TTL/CMOS) Alert switch OR direct output of decay pulses *) ▶ Serial.-115200 baud, 8N1, only Rx/D, Tx/D and GND are used	
Power supply	10.8 ... 15 VDC, <10mA with connected probe	
Software	Radon Vision	

*) If temperature/humidity as well as the Radon/Thoron signal have to be connected to a data acquisition system, the analogous outputs have to be used for temperature and humidity. To log the Radon value use the digital output. The count rate of the transferred decay pulses is proportional to the Radon concentration. In this case the alert function is not available.

RTM 1688-2

Radon and Thoron monitor



The RTM1688-2 is a true universal Radon/Thoron Monitor covering the whole range of Radon measurements. The high sensitivity combined with the alpha spectroscopic analysis will cause a response time as short as physical possible even at low Radon concentrations. The Thoron concentration will be determined simultaneously.

Radon entry paths can be discovered by the “sniffing” mode. Soil gas sampling as well as Radon in water measurements are simple because of the built in pump. The operation of the instrument is realised by only one button. A serial printer may be connected to the interface of the RTM1688-2 to present a protocol directly on site.

The instrument can be directly connected to a modem (analogue, ISDN, GSM) for remote data transmission. The Radon Vision software (included in delivery) handles the telephone connection as simple as a direct cable link.

The measurement chamber is not sensitive against humidity variations – a drying tube, commonly used in such instrument types, is not required.

Special attention was paid for the issue of quality assurance. Each stored data record contains a complete Alpha spectrum which shows the error-free operation of the instrument for each single integration interval. Any number of measurement series may be created by starting/stopping the data acquisition. The data stored within the instrument can be read by PC even if a measurement is in progress.

The small chamber volume of only 130 ml must be pointed out. The measurement of probes taken from small and limited volumes is possible due to this property. The RTM1688-2 can be powered either by a mains power adapter or by the internal battery which gives an autonomous operation time up to 14 days.

As a matter of course the instrument is equipped with sensors for temperature, humidity and barometric pressure. An integrated tilt detector will give a signal if the instrument has been removed from its original position during the measurement.

RTM 1688-2

Radon and Thoron monitor

Chamber	Optimised high voltage chamber with electrostatic focus of short living Radon daughters generated inside the chamber at the surface of a semiconductor detector <ul style="list-style-type: none">▶ No changes of the sensitivity due to the ambient humidity▶ Usage of a drying tube or similar equipment is NOT required!▶ High sensitivity at low chamber volume (approx. 130 mL)
Analysis	Spectrometric analysis of the short living Radon daughters <ul style="list-style-type: none">▶ Minimum possible response time using the Fast-Mode (95% within 12 minutes)▶ Double sensitivity using the Slow-Mode (including Po-214)▶ Measurement of the Thoron (Rn-220) concentration▶ No contamination by long living Radon daughters▶ 100% quality assurance by readable Alpha spectrums
Measurement Range	0 ... 10 MBq/m ³
Sensitivity	3/7 counts/Minute @ 1000 Bq/m ³ (Fast/Slow-Mode) <ul style="list-style-type: none">▶ 200 Bq/m³ with a 10% statistical error (1s) at a 1h sample interval▶ 10 Bq/m³ with a 25% statistical error (1s) at a 4h sample interval
Sensors included for	<ul style="list-style-type: none">▶ Relative humidity (0 ... 100%)▶ Temperature (-20 ... 40°C)▶ Barometric pressure (800 ... 1200mbar)▶ Tamper
Sample interval	from 1 Minute to 4 hours, 1 Minute steps
Pumpe	Internal sampling pump (0.30 L/min continuous and interval mode)
Memory	Non volatile memory for 2047 data records (circle architecture), Alpha Spectrum included
Power supply	by AC/DC wall adapter and internal rechargeable battery (battery operation up to 14 days)
Control	One button control (lock-function) Display (3 x 16 characters) with back-light
Dimensions/ Weight	232 x 182 x 135 mm, 3.5 kg
Interface	Serial interface for set-up and data transfer (also with USB adapter or modem) Internal buzzer for alert function and Radon-„Sniffing“
Software	Radon Vision Software included

RTM 1688-2 Geo Station Radon and Thoron monitor



This special version of the RTM1688-2 offers a turn-key system for the stationary monitoring of Radon gas activity concentration in the soil. The internal measurement chamber of the standard version has been replaced by the separate soil gas probe.

The probe contains the Radon measurement chamber as well as the sensors for temperature and humidity and the shock detector. The compact and rough cover made from stainless steel and Acetal allows the usage of the probe inside bore holes from 80mm up.

All electronics and the detector are protected by a special Urethane coating to ensure a long operation time even under extreme conditions as expected in seismic and volcanic active areas (e.g. H2S). A large area Silicon rubber diffusion membrane results in short response time. We guarantee a water tightness up to 1 Meter immersion depth.

The control panel of the instrument and the rechargeable battery 12V/12Ah are installed inside a solid and sealed (IP66) Aluminium enclosure. Optionally, a GSM modem and a clock timer to switch on/off the modem periodically are available.

The battery enables an autonomous operation of more than 60 days. An external power supply, either a mains power adapter or a solar panel can be connected to recharge the battery permanently. Only a few hand movements are necessary to replace the internal battery by an external one with higher capacity.

The soil gas probe is connected by an up to 10 m long cable. All connections (soil gas probe, external power, external battery) and the cable feed-through are placed on the bottom panel of the unit.

The instrument comes with the latest Radon Vision software.

RTM 1688-2 Geo Station Radon and Thoron monitor

Theory of Operation	High voltage biased chamber with semiconductor detector
Diffusion membrane	Silicon rubber; diameter 67 mm
Sensitivity	1.5 cpm @ 1000Bq/m ³
Measurement Range	▶ Radon: 0 ... 10 MBq/m ³ (inside the probe)
Response time	dependent on the diffusion membrane (min. 15 min)
Sensors	▶ Temperature: -20 ... 40°C (inside the probe) ▶ Humidity: 0 ... 100% (inside the probe) ▶ Shock: 2g (inside the probe) ▶ Bar. Pressure: 800 ... 1200mbar (inside the control unit, with hose fitting)
Probe connection	7-pin receptacle (max. length of cable 10 m)
Sample interval	1 minute to 4 hours, adjustable in 1 Minute steps
Memory	2047 records (circular), Alpha spectrum included
Operation	Single button (lock-function)
Display	with back light (3 lines x 16 characters)
Interface	RS232 for set-up/data transfer (accepts USB adapter or modem)
Probe	Housing made from stainless steel and Acetal; Water tight up to 1m, 128 mm, (without receptacle) x 79 mm (diameter)
Weight	650 g;
Control unit	powder-coated Aluminium enclosure (IP66),
Dimensions/ Weight	230 x 280 x 111 mm (W x H x D); 5 kg (incl. battery)
Power supply	Internal (12V/12Ah) or external battery, additional connector for mains power adapter or solar panel

RTM 2200

Radon and Thoron measurement system



Even in the basic version, the RTM2200 represents the perfect Radon/Thoron monitor for any kind of Radon measurements. The outstanding performance of the unit becomes really visible if complex sampling procedures must be applied. Due to its versatile possibilities for connecting additional sensors and actors, a multi-parameter station can be created without effort. The RTM2200 is not limited to the data acquisition but is also able to control equipment which is required for the sampling (e.g. pumps, valves, positioning etc.).

By connection of up to four additional Radon chambers (soil gas probe, indoor air sensor) is it possible to measure the Radon concentration in different rooms with one monitor. Additional differential pressure and temperature sensors may complete a sampling system to investigate the Radon transportation processes in buildings and facilities. Another application is the geo-physical instrumentation where the water analytics and the sampling of soil gases can be integrated. A spectroscopic NaI(Tl) gamma detector and/or gas sensors for Carbon Monoxide and combustible gases are very helpful for the mining and Uranium industry. There is no limit for your ideas.

The Radon measurement chamber, based on the principle of high voltage collection, offers a high sensitivity at a small internal volume. This is big advantage for Thoron sensitivity and it allows to use a small pump rate which is often important (soil gas sampling). The long term contamination by Po-210, known from other measurement principles is completely rejected. There is no cross sensitivity to ambient gamma radiation. Due to the special design, the chamber is not sensitive against variations of the ambient humidity. The commonly used drying equipment for instruments using this principle is for the RTM2200 not required. We use high quality silicon radiation detectors inside the chamber to separate the various radon daughter products by Alpha spectroscopy.

Quality assurance is a basic item of any radiation measurement. Therefore, the RTM2200 saves a complete Alpha spectrum for each data record. The spectrum always indicates an error free operation of the unit.

All results are presented on a large display with touch buttons. A SD memory card allows collecting of a huge amount of data if necessary. Each record will be stamped by the GPS coordinates if the GPS option has been chosen. Data transfer is realized by USB port and serial interface (RS232). The RS232 allows the connection of GSM modems. Optionally, the serial port can be replaced by an integrated wireless network adapter (Net Monitors).

RTM 2200

Radon and Thoron measurement system

Radon chamber	Internal
Detector	4 x 200mm ² ion-implanted silicon detector
Internal volume	250mm ³ (total volume of the internal air loop)
Measurement Range	0...10 MBq/m ³
Sensitivity	3 or 7 cpm/(kBq/m ³) for fast or slow mode
Response time	12 or 120 min for fast or slow mode
Results	Radon concentration fast (excl. Po-214) and slow (incl. Po-214) Thoron concentration Storage of time distribution and spectra
Pump	High quality membrane pump Flow rate 0.3 l/min controlled by processor
Gamma probe (option)	<i>Connected by a cable to front panel of the RTM2200</i>
Detector	Nal(Tl) with integrated PMT and HV supply <ul style="list-style-type: none">▶ Scintillation crystal 2" x 2"▶ Energy range for Spectroscopy 10 keV – 1,5 MeV▶ Resolution 8% (Cs-137)
Results	Local dose rate, net activity of seven user defined nuclides <ul style="list-style-type: none">▶ Storage of time distribution and spectra
Dimensions of probe	Diameter 60 mm, Length 260 mm <ul style="list-style-type: none">▶ Connection cable 5 m (optional 10 m)
Additional Radon chambers	<i>Connected by a cable to front panel of the RTM2200</i>
Soil gas probe	Stainless steel probe for permanent installation in the soil, additional sensors for humidity and temperature (for specification see data sheet)
Indoor air sensor	Like internal Radon chamber, pump or diffusion (for specification see data sheet)
Results	Like internal Radon chamber
Additional sensors	
Standard unit (internal)	Rel. humidity 0 ...100%, accuracy ± 2% Temperature -20 ... 40°C, accuracy ± 0.5°C Bar. pressure 800 ... 1200mbar, accuracy 0.5% MW Flow rate 0 ... 0.6 l/min, accuracy ± 5% Humidity/temperature sensor inside the air internal air loop
Air analytic (option)	CO, CO ₂ , CH ₄ , combustible gases etc., various ranges available
Water analytic (option)	pH-value, redox potential, conductivity etc.

RTM 2200

Radon and Thoron measurement system

Process (option)	Pressure, differential pressure, flow rate, stream velocity, soil moisture etc.
Meteorology (Option)	Wind direction, Wind speed etc.
Common	
Sampling	Simultaneous sampling of all detectors/sensors with respect to the selected sampling program
Sampling programs	Storage of up to 16 sampling programs with up to 32 steps (defined or infinite repetition) Sampling interval from one second to weeks
Memory	SD card, 2 GB (larger cards can be also inserted)
Control/Display	Touch screen 6 x 9 cm wide Interfaces: USB and RS232 (or wireless network adapter)
Power supply	Internal 12V rechargeable battery, AC/DC wall adapter Option: additional connector for 12V car battery or solar power station
Dimensions/weight	235mm x 140 mm x 255 mm / approx. 6 kg
Software	dVISION: Control and data transfer (also via GPRS, GSM, Net Monitors), visualization, data management dCONFIG: system configuration, creating/changing cycles (also via GPRS, GSM, Net Monitors) dLIBRARY: Library for NaI gamma probe (option)
Extensions	Internal screw terminals 8 analogous inputs, 3 counter inputs, 2 status inputs, 6 switch outputs, clock timer, PID-regulator/analogous output: USB
GPS (option)	IGPS coordinates are recorded and stored together with the measurement results. GIS compatible *.kml files can be exported (can be opened by Google-Earth). Antenna connected by cable.
Accessory	
Included	<ul style="list-style-type: none"> ▶ Charger ▶ USB - cable ▶ Serial cable
Optional	<ul style="list-style-type: none"> ▶ Transportation box ▶ Soil gas set (simple or packer) ▶ Exhalation bonnet ▶ Radon in water sampling kit ▶ Gas drying unit (Peltier cooler) for stationary water sampling ▶ GSM modem incl. AC/DC adapter and cables

Radon Soil Gas Probe

Radon monitor & transmitter



The soil gas probe was developed especially for geophysical applications. The compact and rough cover made from stainless steel and Acetal allows the usage of the probe inside bore holes from 80 mm up.

The electronic as well as the detector are protected by a special Urethane coating to ensure a long operation time even under extreme conditions as expected in seismic and volcanic active areas (e.g. H₂S). A large area Silicon diffusion membrane causes a short response time.

We guarantee a water tightness up to 1 Meter immersion depth. Sensors for temperature and humidity are integrated in addition to the Radon chamber.

The soil gas probe is connected to the Analogues Radon Sensor (ARS) by a single cable which can reach a length of up to 10 Meters. The Analogues Radon Sensor calculates the current Radon concentration and generates an analogous output signal. Alternatively, a switch output – programmable either as alert or counting output - is available. A serial interface (RS232) serves to program the operation parameter and to read the current values directly from the unit. The transfer protocol is supplied by the manufacturer to realise own communication solutions.

If the system shall be used as a „stand alone“ solution, a internal data logger stores the acquired time distribution. In case of a power interruption, the Analogues Radon Sensor will start again the data acquisition automatically.

The low power consumption offers the possibility to install the system without developed infrastructure using solar power supplies.

The unit will be shipped with the latest version of the Radon Vision software.

Gas Sensors

Sensors for many different target gases

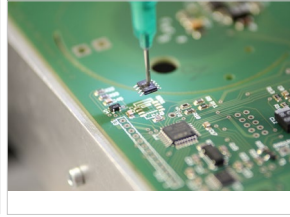

Gas Sensors for RTM2200, RPM2200, EQF 3200 and EQF 3220 and A²M4000

SARAD offers a wide range of gas sensors for various applications. These sensors can be mostly integrated into the enclosure of the instrument. Of course it is also possible to integrate OEM sensors chosen by the customer if the output signals are compatible with our instruments.

Due to the big number of target gases, different measurement principles with different behaviour regarding range, uncertainty, cross sensitivity and ambient conditions must be considered. Each user should clarify in advance the conditions and requirements for his application to select the best suited sensor.

Beside very complex and expensive analysis methods like gas chromatography or infrared gas spectroscopy, three major measurement principles are commonly used for monitoring and testing:

Non-dispersive infrared sensors (NDIR)	Semiconductor sensors based on metal oxide	Electrochemical Sensors
High accuracy (sometimes below 1%)	Less accuracy (10%)	Less accuracy (5%), better than metal oxide
Wide measurement range (variable by size of gas gauge)	High sensitivity for low gas concentrations	High sensitivity for low gas concentrations
Long term stable (dependent on light source and receiver)	Good long term stability (but sensitive against silicon gases)	Less long term stable by catalytic processes, periodical replacement required
Low cross sensitivity to other gases	Moderate cross sensitivity	Moderate cross sensitivity
High power consumption	Medium power consumption	Low power consumption
Expensive	Sensor elements inexpensive	Sensor elements more expensive than metal oxide, depending on target gas

Table 1 – comparison of operational principles

Gas Sensors

Sensors for many different target gases

With respect to the most frequent application fields we offer a number of standard sensors for our monitors. We use our own gas transmitters in case of semiconductor and electrochemical sensors. In case of NDIR sensors we implement parts from leading companies in this field.

Semiconductor sensors

This kind of sensors is mostly used in the field of gas testing for safety purposes. The combination of CO and combustible gases (Methane) offers a phantastic addition for Radon monitors used in mines or underground facilities. If these sensors are used under moderate and smooth conditions, they will be also suitable for monitoring applications. The SARAD transmitter contains always two different gas sensors. Various combinations of target gases are possible:

	Carbon monoxide (CO)	Methane (CH ₄)	Combustible gases	Ammonia (NH ₃)
Carbon monoxide (CO)		X	X	
Methane (CH ₄)	X		X	X
Combustible gases	X	X		X
Ammonia (NH ₃)		X	X	

Table 2 – Combinations of semiconductor sensors

The sensors are normally placed at the front panel so that they are easily accessible for replacement. If it is necessary to insert the sensors in a closed gas loop, a special cap with hose terminals is available. This cap can be also used for calibration with test gases. Our transmitter is compensated for temperature and humidity changes.

Carbon monoxide (CO)	50 ... 1000 ppm
Methane (CH ₄)	500 ... 10000 ppm
Ammonia (NH ₃)	30 ... 300 ppm
General combustible gases	500 ... 10000 ppm
FCKW (CFC)	5 ... 100 ppm

Table 3 – Available semiconductor gas sensors

The transmitters are connected to the internal serial bus system of the monitor. Therefore it is possible to connect multiple transmitters.

NDIR sensors

The two very important soil gases, Methane and Carbon dioxide, can be measured by non-dispersive infrared technology. This principle of operation allows very accurate measurements in the percentage range of the target gas concentration. By the variation of the sensor gauge it is possible to create several measurement ranges for best fitting to the application. We integrate the sensors into the internal gas loop of our monitors. Due to the space requirements, the standard 25 cm wide instrument enclosure must be replaced by a 32 cm wide housing. As an alternative, the sensor can be placed in an external box with hose terminals and cable connection. This enables the mounting into external gas channels.

Gas Sensors

Sensors for many different target gases

Carbon Dioxide (CO₂)	0 ... 10% 0 ... 25% 0 ... 50% 0 ... 100%
Methane (CH₄)	0 ... 1% 0 ... 2.5% 0 ... 5% 0 ... 20% 0 ... 100%

Table 4 – list of available NDIR gas sensors

Electrochemical sensors

Electrochemical sensors offer the widest range of target gases. They offer good repetition accuracy and are used for monitoring as well as gas safety tests. The life time of the sensor elements is limited by the chemical processes of the electrolyte. Normally, two years of operation are guaranteed. The chemical process takes also place if no circuit voltage is applied. Therefore, a cyclic replacement is strictly required.

Oxygen (O₂)	0 ... 50 bis 0...2000 ppm
Hydrogen Sulfide (H₂S)	0 ... 10 und 0 ... 2000 ppm
Phosphene (PH₃)	0 ... 50 und 0 ... 100 ppm
Hydrogen Cyanide (HCN)	0 ... 20 bis 0... 100 ppm
Hydrogen Chloride / Hydrogen Bromide	0 ... 20 ppm
Chlorine (Cl₂)	0 ... 20 ppm
Nitrogen Dioxide (NO₂)	0 ... 100 bis 0 ... 5000 ppm
Nitrogen Monoxide (NO)	0 ... 20 bis 0 ... 2000 ppm
Sulfur Dioxide (SO₂)	

Table 5 – list of available electrochemical gas sensors

Our transmitters offer an analogous output signal of 0...5V and can be directly connected to the sensor inputs of our monitors. The electrical mechanical design allows simple cascading of multiple sensors on a rail to save space and to keep the internal gas volume as low as possible. Dependent on the number of sensors which shall be integrated, a wider enclosure (32 cm instead of 25 cm) may be required. If no analogous inputs of the monitor are occupied by other analogous sensors, up to eight electrochemical gas transmitters can be connected in parallel.

Pollution Monitoring Station Autonomous immission monitor



The measuring container represents an efficient and sound overall concept including all electrical, climatical and meteorological units as well as the entire system and network for data logging and transmission.

The facts in a brief overview:

All measuring devices inside the container deliver their data continuously to a data logging unit, the so called „data logger“, which is steadily forwarding the collected data or results to the control center in fixed. The measuring devices work on well proven physical measuring principles and monitor the concentration of a huge variety of dangerous pollutants.

The container is well insulated and equipped with a heating as well as an air conditioning system. Therefore a functionality of all units is guaranteed also under the worst weather conditions. Anti-theft alarm system and a security door make the container and your data save. The container's siting results from extensive calculations about the pollutants spreading considering their atmospheric sources of emission.

Supervisable pollutants:

Immission

phenol acids (C_6H_6O), benzene (C_6H_6), toluene (C_7H_8), xylene (C_8H_{10}), alpha methylstyrene (C_9H_{10}), dimethylamine (C_2H_7Cl), methyl-2-butene (C_5H_{10}), pentane (C_5H_{12}), chloroform ($CHCl_3$), chloroethene (C_2H_3Cl), dichloroethane ($C_2H_4Cl_2$), methanol (CH_3OH), carbon monoxide (CO), nitrogen oxide (NO), nitrogen dioxide (NO_2), sulphur dioxide (SO_2), dust, ozone (O_3), hydrogen sulphide (H_2S), ammonia (NH_3), chlorine (Cl), hydrogen chloride (HCl), chloric acid gas ($HClO_3$), hydro carbons

Emission

dimethylamine (C_2H_7Cl), methanol (CH_3OH), toluene (C_7H_8), chloroethene (C_2H_3Cl), alpha methylstyrene (C_9H_{10}), pentene (C_5H_{10}), pentane (C_5H_{12}), dichloroethane ($C_2H_4Cl_2$), carbon monoxide (CO), ammonia (NH_3), hydrogen sulphide (H_2S)

Our services for you:

- ▶ installation of the container
- ▶ siting of the container
- ▶ maintenance of the container

Pollution Monitoring

Autonomous immission/emmission monitoring



Important industrial centres in the world provide people with the financial means for their living and with certain wealth.

However, the concentration of industrial operations and the high transportation density result in heavy environmental burdens. In order to document such loads and to identify the correlation between emission and immission (between the output by polluters and the exposure to pollutants) in an industrial conglomerate, complex measuring programmes have been put in place.

We as professionals in the field of pollution monitoring have built systems for both immission and emission monitoring.

In cities, a network of immission-measuring containers is being installed to register a wide range of pollutants. At the same time, the exhaust gases emitted by the biggest industrial factories are measured.

Based on the collected data, a correlation may be established between emission and immission and targeted measures can be taken for improving the air quality.

ASDA 02 Cascade Impactor

Particle size distribution monitor



The health risk of exposure to radon and thoron progeny is influenced by activity-size distribution of the carrier aerosol particles. Therefore, to enable practical measurements of the activity-size distribution to be made under field conditions, SARAD NUCLEAR INSTRUMENTS, in collaboration with the University of Göttingen, the Australian Radiation Laboratory and A.C. James/SARAD Technologies, Inc. (in the USA) has developed a portable measurement system.

This system consists of:

- ▶ Screen for in-situ detection of the atomic portion of Radon decay products
- ▶ A six (optional eight) stage, low pressure cascade impactor for collection and in-situ detection of various particle sizes.
- ▶ Backup filter for size-independent collecting all remaining radioactive particles
- ▶ Full-automatic spectroscopic analysis and deconvolution software

The combination of a screen and a low-pressure impactor allows the determination of activity-size distribution over a very wide range of particle size from 0.6nm to several μm (equivalent particle diameter).

1. Low pressure cascade impactor- The impactor consists of a cascade of 6 (8) stages through which the sampled air will flow at progressively increased velocity. Thus, particles will be separated at each stage according to their aerodynamic diameter: Thus, the first stage will collect the largest particles. Each stage consists of a plate of defined drilled holes through which the air will be sucked in. Opposite the holes there is a foil surface on which that particles will be deposited that cannot follow the deflected air stream.

The activity of the decay products will be analyzed by a semiconductor detector that is arranged behind the foil. A special feature of this impactor type is the impact surfaces that rotate while collecting the particles. In this way, punctually growing deposits on the foil will be avoided (consistently spectral resolution).

All foils can be easily replaced to perform other analyses (e.g. chemical ones) of non-radioactive aerosol particles such as fungal spores, combustion soot, varnish gases, or abrasive dust)

2. Electronics und Software- The radioactive decay products will be converted by a detector / amplifier module in an electrical signal. Each stage has got its own spectrometer that enables to perform a spectrometric assessment of each stage. The whole system is connected with a computer for control and assessment.

SARAD is pleased to acknowledge the scientific works of Prof. J. Porstendörfer and Dr. August Reineking (University of Göttingen/BRD), Dr. Stephen Solomon (Australian Radiation Laboratory) and Dr. Anthony James (A.C. James/SARAD Technologies, Inc./USA) in developing this new system.

ABC Reconnaissance CAR Detection of dangerous materials

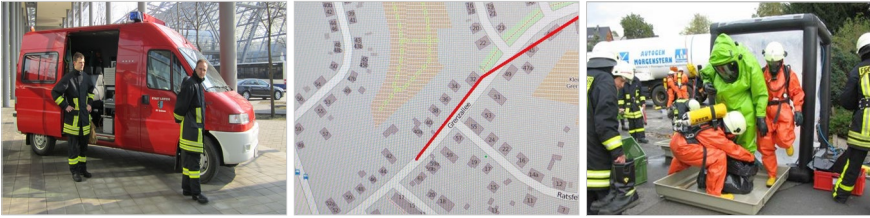

Arising from SARAD's core competence in monitoring the environment the company has developed an

ABC RECONNAISSANCE CAR

with the latest measurement equipment for the detection of dangerous materials. The aim of SARAD's new development is to protect the population against damages of health in case of heavy environmental pollution from the industry, from phenomena of nature, accidents and by terroristic attacks. Ionizing radiation and organic toxic gases are measured during the drive with the aid of the ABC Reconnaissance Car. The car allows its crew to drive to the barrier of an endangered area and to go in wearing ABC protection suits in order to rapidly detect type and strength of such harmful materials. With these data gained and transferred by the car instrumentation the responsible authorities and persons will be quickly in a position, to alert the population, to block the area in question and initiate urgent counter measures, equipped with an advanced equipment for detecting:

Alpha – Beta – Gamma radiations.- The dose rate is measured by a two liter plastic scintillator within a range from 10 nSv/h up to 100 μ Sv/h and by a Geiger-Müller counter up to 1 Sv/h. An additional detector is installed for radioactive aerosols to measure both the alpha and beta radiation.

VOC volatile organic compounds concentrations.- by using latest photo-ionization detectors for more than 200 compounds

Toxic industrial gases or chemical warfare.- agents by means of an ion mobility spectrometer for agents such as chlorine, cyanides, sulphur dioxide, chloro-organic compounds CLX as well as chemical warfare agents such as Tabun, Sarin, VX, Soman, Nitrogen Mustard to mention but some from the list of possible materials.

Protection of people

SARAD ABC Car – a necessary means for the protection of people to be used by the Security Authorities of towns, airports, for large sports events, for any large gathering of people, large industrial areas, for fire fighting and more.

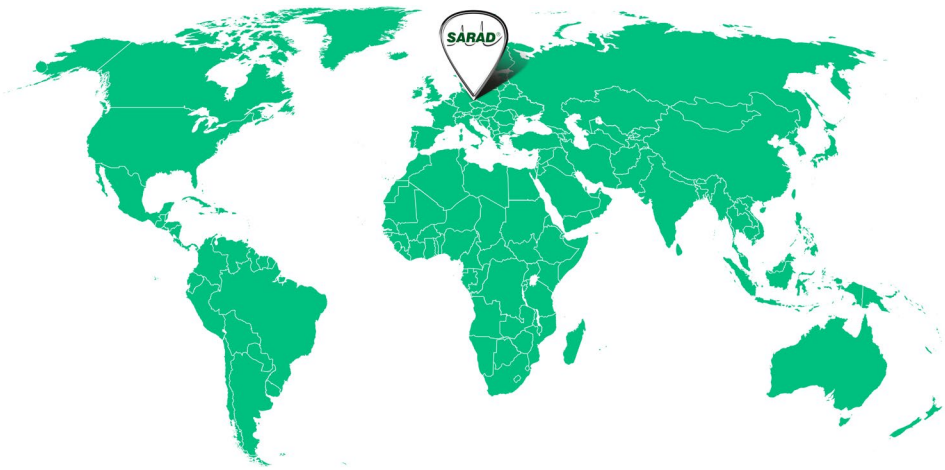

SARAD GmbH
Wiesbadener Str. 10
01159 Dresden

Tel: +49 351 6580721
Fax: +49 351 6580718
E-Mail: sales@sarad.de
Web: www.sarad.de

VAT-No:DE 155 300 188